

 **Elemental  
Microanalysis**



catalogue | A world of products for  
**Macro CN/CHN/CNS/N-protein analysis**

# Contents

4 Introduction

## Products for Elemental®

6 Chemical supplies

7 Capsules, foils & crucibles

8 Quartz, glassware & furnace tubes

10 O-rings & seals

11 Other operating supplies

## Products for Leco®

12 Chemical supplies

13 Capsules, boats & crucibles

14 Quartz, glassware & furnace tubes

16 O-rings & seals

18 Other operating supplies

20 Reference materials

24 Cross references

33 Literature request form

## Introduction

### About the Company

Elemental Microanalysis has grown from small beginnings over 40 years ago as a micro-analytical laboratory to its current form as a leading manufacturer and supplier of consumables, supplies and other products for elemental analysers. We operate from our purpose-built factory, warehouse and laboratory complex in Devon, UK.



You learn a lot in 40 years – a lot about your products – how to make them and how to use them, a lot about your customers and their needs. We have been developing, refining and using products for elemental analysis since 1976 and have a unique in-depth knowledge of instruments from all manufacturers.

These days we offer the world's largest range of products for elemental analysers, sending our products to customers across the globe. We take

great care with the quality of our products. The vast majority are manufactured in-house by our trained technicians within our ISO 9001:2015 accredited quality system. But we don't just make the products – we use them every day in our own analytical laboratory, giving us constant feedback on their performance. We do not compromise on quality and don't expect you to either. Our total satisfaction guarantee backs up our commitment to our product quality.

'Price is what you pay, value is what you get'.

As the leading independent supplier of elemental analysis consumables we can offer substantial savings in comparison to the prices charged by the original supplier of your instrument. But we know that you need more from a supplier than simply low prices. You need to buy with the confidence that your analysis will not be compromised by poor quality consumables and the knowledge that your supplier has all the resources to provide the full range of support that you expect.

We will always treat our customers with honesty and integrity. If we do make a mistake we don't try to hide it – we recognise it and put it right.

We won't sell you short measure and we won't mislead you in any way. Our business is built on long-term relationships, as our customers will testify – many have been with us for more than 30 years.





**'price is what you pay – value is what you get'**

## Guaranteed quality

Our quality system is certified to BS EN ISO 9001:2015 by LRQA, our laboratory has UKAS ISO/IEC 17025:2005 accreditation, and we have ISO 17034:2016 accreditation of the production process for certified reference materials. Our confidence in our products allows us to offer you a total satisfaction guarantee: if our product does not perform at least as well as the brand of product you usually use, you can return it for a full refund.



4260



6620



## Try our products – free of charge!

Try before you buy – we have sample packs available for most elemental analysers on the market. Just let us know the instrument you have and we will send you a trial quantity of 3–4 different consumables to try – free and with no obligation. Offer limited to one per customer.

## Sales service

Our friendly sales staff will ensure that your order is despatched promptly and correctly. They can tell you about our stock levels, prices, shipping arrangements, or answer any other queries you may have.

Most orders are despatched within 24 hours of receipt. Rush orders receive special attention and are processed immediately. If you have an urgent problem or need priority despatch, please let us know.



## Technical service

In this catalogue we have tried to provide the most accurate and complete information possible about our ever-expanding range. We realise, however, that you may require additional technical information.

For this reason we have technical specialists on hand to answer your questions and advise you on selecting the products best suited to your needs. We can also supply samples, and even develop new products for your particular application.

## Design changes

We are constantly working on improving our products and these improvements may mean that some products differ from the descriptions in this catalogue. Our technical staff are happy to discuss any improvements made, and the resultant benefits. Check the website and join our mailing list to keep up-to-date with the latest products and developments.

## Chemical supplies

Macro CN/CHN/CNS/N-Protein analysis

Cat No	Description	Pack	Elementar part
B1090	Alumina (Aluminium Oxide) Spheres 3 to 6mm	50g	50 008 467
B1093	Alumina (Aluminium Oxide) Spheres 3 to 6mm	250g	
B1089	Alumina (Aluminium Oxide) Wool Fine	20g	05 000 086
B1304	Brass wool	50g	38.00-0124
B1270	Cerium Dioxide Fused Granular	100g	05 000 469
B1219	Cerium Dioxide Granular	100g	03 679 915
B1218	Copper Oxide Wires (Coarse) Coarse wires 6 x 0.65mm	250g	03 679 905
B1122	Copper Oxide Wires Fine Wires 4 x 0.5mm	250g	05 001 039
B1206	Copper Oxide Wires Fine Wires 4 x 0.5mm	1kg	
B1209	Copper Oxide Wires Fine Wires 4 x 0.5mm	3kg	
B1015M	Copper Wires Fine Wires Reduced 4 x 0.5mm	100g	05 000 699
B1049M	Copper Wires (3 x 50g) Fine Wires Reduced 4 x 0.5mm	150g	
B1091M	Copper Wires 3x100g Pack Fine Wires Reduced 4 x 0.5mm	300g	
B1083M	Copper Wires Pound Pack Fine Wires Reduced 4 x 0.5mm	454g	
B1212M	Copper Wires Fine Wires Reduced 4 x 0.5mm	1kg	
⚠ B1161	EMADrone Magnesium Perchlorate 501-171	454g	
⚠ B1115	EMASorb A Granular 0.8 to 1.6mm 14 to 25 mesh	200g	03 679 900
⚠ B1162	EMASorb A Granular 0.8 to 1.6mm 14 to 25 mesh	500g	03 679 900
⚠ B1164	EMASorb B Granular 1.6 to 3mm 7 to 14 mesh	500g	
B1204	Manganese Dioxide Sulphur Reduction in U-Tube	10g	05 000 880
B1246	Platinum Catalyst 0.5% Pt	30g	
B1196	Platinum Catalyst 5% Pt	30g	03 002 262
B1308	Platinum Catalyst 5% Pt	150g	03002262
B1305	Post combustion reagent for exceed® instruments	500g	16.02-0056
⚠ B1297	Sicapent	30g	03960352
⚠ B1197	Sicapent (2.8L)	500g	03 960 352
B1214	Silica (Quartz) Chips Granular 1 to 2mm	100g	03 679 907
B1215	Silica (Quartz) Chips Granular 2 to 4mm	50g	05 000 900
B1216	Silica (Quartz) Chips Granular 2 to 4mm	100g	
B1255	Silica (Quartz) Wool Discs 24mm Diameter	25	
B1208	Silica (Quartz) Wool Very Fine	10g	03 679 908
B1276	Silica (Quartz) Wool Very Fine	15g	
B1102	Silica (Quartz) Wool Very Fine	50g	0240-1118
B1231	Silver Wool 0.05mm Fine Wire	50g	22 131 365
B1404	THAM Tris (hydroxymethyl) aminomethane	80g	
B1217	Tungsten (VI) Oxide Granular	60g	11.02-0008
B1299	Tungsten (VI) Oxide Granular	300g	11.02-0008
B4014	Tungsten (VI) Oxide Powder	90g	11.02-0024
B4013	Tungsten (VI) Oxide Powder Fine Powder	25g	11.02-0017
B1205	Tungsten Granulated	500g	12.00-0040
B1210	Tungsten Granulated (Bulk)	2.5kg	12.00-0040
B1203	Tungsten Kit Complete – 500g of Tungsten Granulated +25 Gauzes		12.01-0045
B1406	Zinc granules	50g	29.00-0092
B1407	Zinc granules	200g	29.00-0092



Silver wool 0.05mm fine wire  
B1231



Tungsten (VI) oxide granular  
B1217, B1299



Copper wires,  
fine, reduced  
B1015M



Tungsten kit complete B1203

Tungsten (500g in kit)

Stainless gauze  
(25 in kit)

⚠ These products are classified as dangerous for shipping

Zinc granules  
B1406



Silica (quartz) wool discs  
24mm diameter  
- pack of 25  
B1255



Platinum catalyst 5% Pt  
B1196



Tin foil squares  
standard weight 50 x 50 mm  
D1115

Cat No	Description	Pack	Elementar part
C3058	Ceramic Crucible	100	25.00-1123
C3064	Metal crucibles	100	03 002 278
D1117	Rapid Caps	190	05 001 013
D2084	Silver Squares 35 x 35mm	100	
D9001	Tin Foil Cones Standard Weight	100	05 000 429
D9010	Tin Foil Cones Standard Weight	1500	
D9002	Tin Foil Cones, Large, Standard Weight	100	
D9003	Tin Foil Cones, Large, Standard Weight	400	
D1116	Tin Foil Squares Standard Weight 37 x 37mm	400	12.01-0032
D1115	Tin Foil Squares Standard Weight 50 x 50mm	100	12.01-1012/4
D1118	Tin Foil Squares Standard Weight 50 x 50mm	500	
D1119	Tin Foil Squares Standard Weight 50 x 50mm	1500	

### We support the following Macro analysers from Elementar:

**Elementar rapid N**  
**Elementar rapid N cube**  
**Elementar rapid N exceed<sup>®</sup>**  
**Elementar rapid MAX N exceed<sup>®</sup>**  
**Elementar vario MAX**  
**Elementar vario MAX cube**  
**Elementar vario MACRO**  
**Elementar vario MACRO cube**

Please contact us for a Product Sheet specifically for your analyser, or use Advanced Search on our website and select the analyser you require.

Do you want to find a product using the manufacturer part number?  
— Use the cross reference lists, beginning on page 24.

For our extensive range of reference materials, see pages 20 – 23.

Metal crucibles  
C3064



Ceramic crucible  
C3058



Tin foil cones  
standard weight  
D9001



Large tin foil cones  
standard weight  
D9002



## Quartz, glassware & furnace tubes

Macro CN/CHN/CNS/N-Protein analysis

Cat No	Description	Pack	Elementar part
C3065	Ash crucible rapid N exceed®	1	16.00-1104
C3063	Ash Finger 60mm Stainless Steel	1	11001363/4
C3062	Ash Finger 90mm Stainless Steel	1	11.45-1005/4
C3030	Ash Finger Ceramic rapid N	1	05 000 087
C3018	Ash finger - quartz	1	11.00-1170/4
C3024	Ash finger - quartz closed end	1	11.02-1036/4
C3070	Ash finger - quartz closed end, pack of 10	10	11.02-1036/4
C3060	Ash Finger quartz pack of 10	10	11.00-1170/4
C3031	Ash Finger Stainless Steel	1	12.00-1087/4
C3009	Combustion/Reduction Tube	1	11.00-1150/4
C3044	Combustion tube quartz vario MAX	1	25.00-1028
C3067	Combustion tube quartz, vario MAX cube	1	29.00-1078
C3041	Combustion Tube S/S (from SN 12991001)	1	12.01-1036/4
C3069	Combustion tube stainless steel Rapid N exceed®	1	16.02-0036
C3043	Combustion Tube stainless steel vario MAX	1	25.00-1030
C3042	Post Combustion Tube	1	25.00-1048
X2507	Prepacked reduction tube exceed® instruments quartz	1	16.02-0055
C3049	Quartz reduction tube 29mm modified with constriction	1	
C3040	Quartz Reduction/Tungsten Tube 29mm (from SN 12991001)	1	25.00-0017
C3055	SS combustion tube vario MAX cube	1	29.00-1030

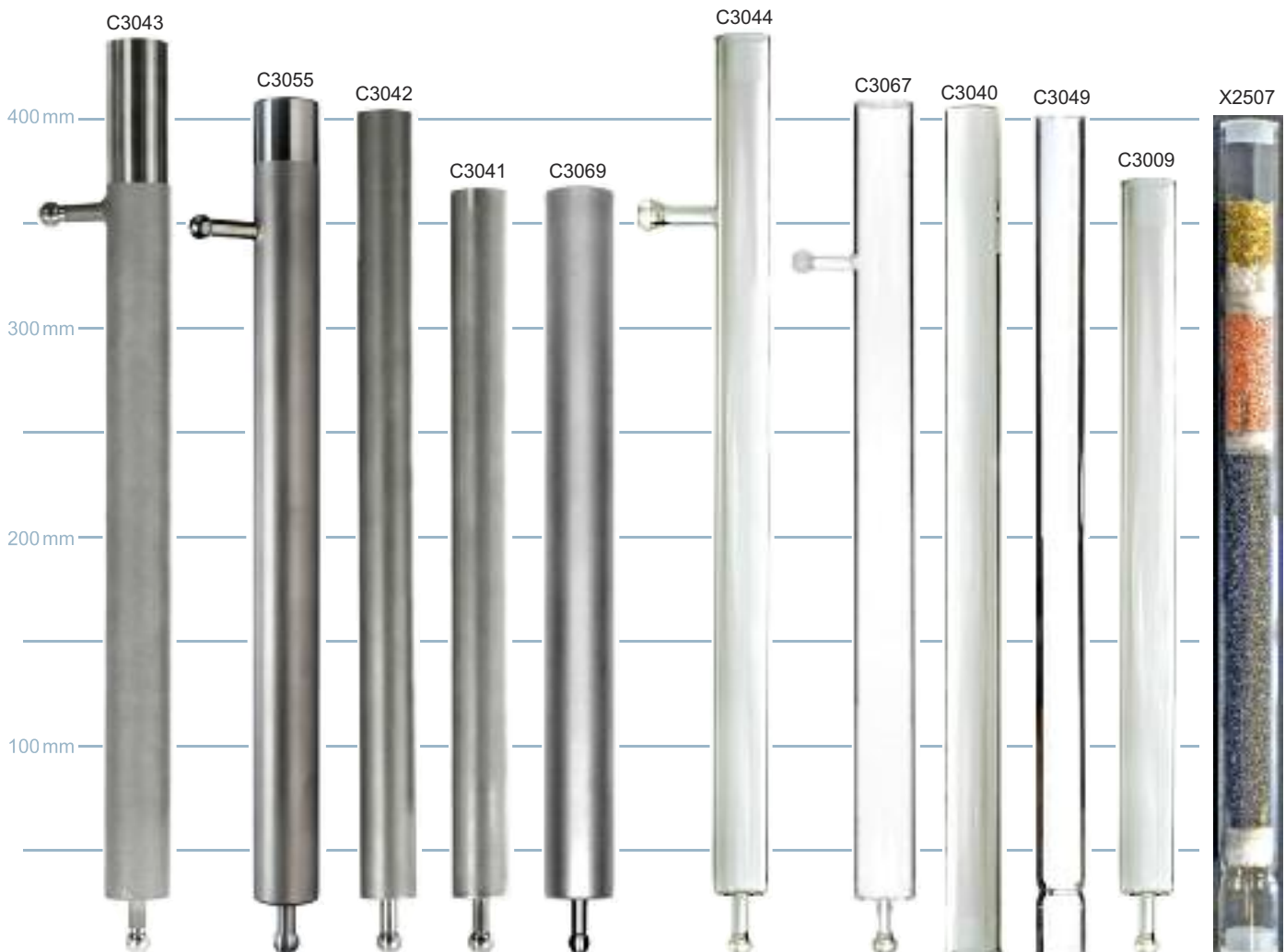

Cat No	Description	Pack	Elementar part
C3008	Drying Guard Tube Borosilicate Elementar	1	22 160 200/4
C1143	Drying tube	1	15.00-0080
C3026	Drying tube 348 mm GL25	1	16.00-1012
C3047	Drying tube short	1	16.00-1037
C3066	Drying tube with GL14 end caps	1	22 160 204/4
C3045	Filter tube	1	50 009 375/4
⚠ X3022	Prepacked sicapent filled C3008 trap	1	
⚠ X3023	Prepacked sicapent filled C3038 U-tube trap	1	
⚠ X3024	Prepacked sicapent filled C3026 trap	1	
⚠ X3025	Prepacked sicapent filled C3047 trap	1	
⚠ X3026	Prepacked sicapent filled C1143 trap	1	
⚠ X3027	Prepacked ½ filled sicapent C3038 U-tube trap & separate bottle of Emasorb filling		
⚠ X3028	Prepacked ½ filled sicapent C3047 trap & separate bottle of Emasorb filling		
C3123	U Tube GL14	1	23.00-0080
C3038	U-Tube Large Complete with GL18 Caps	1	34 001 339/4

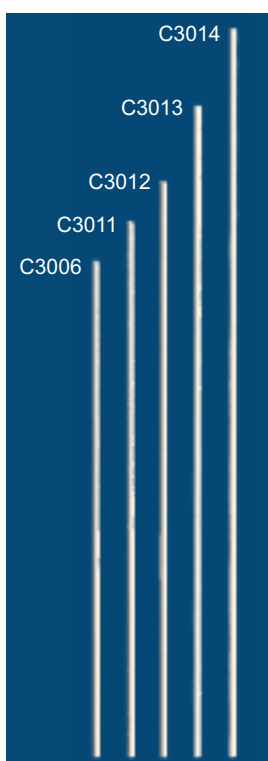
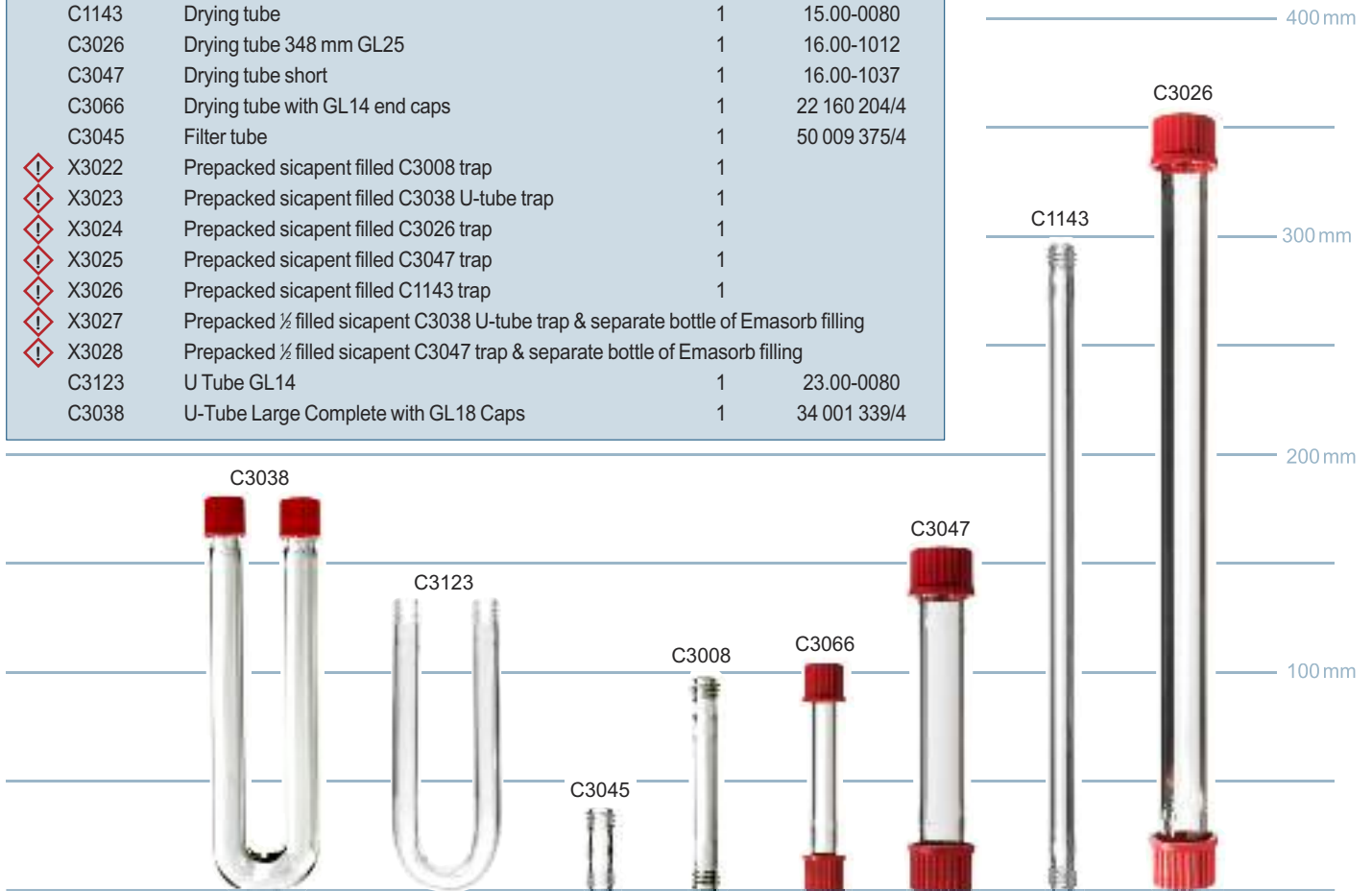

Cat No	Description	Pack	Elementar part
C3022	Connecting tube transparent silica 65mm (Includes O-rings)	1	11.00-1331/4
C3025	Connecting tube transparent silica 130mm (Includes O-rings)	1	25.20-1003
C3006	Oxygen Lance 130mm	1	
C3011	Oxygen Lance 140mm	1	05 000 088
C3012	Oxygen lance 150mm	1	05000354
C3013	Oxygen lance 170mm	1	05 000 658
C3014	Oxygen lance 190mm	1	11.45-1012/4
C3021	Protection tube 105mm	1	11001317/4
C3059	Protection tube 105mm (alt to C3021 without slits)	1	11001317/4
C3053	support rod, reduction tube 65mm	1	11.00-1364/4
C3017	Support tube 65mm	1	11 001 172/4

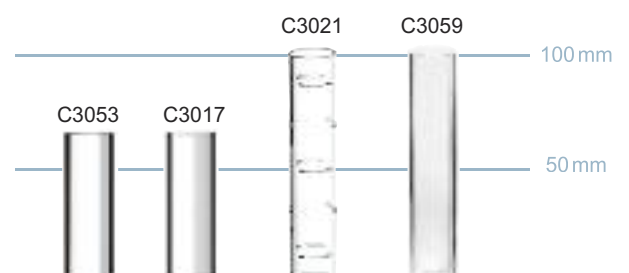



## O-rings & seals

Macro CN/CHN/CNS/N-Protein analysis

O-rings  
are shown  
actual size

Cat No	Description	Pack	Elementar part
E1050	Seal for Oxygen lance viton rubber	1	05 000 247
E1050-10	Seal for Oxygen lance viton rubber pack of 10	10	05 000 247
E1054	Quadring Viton Rubber, 7.65mm x 1.78mm	1	05 000 353
E1054-10	Quadring Viton Rubber, 7.65mm x 1.78mm pack of 10	10	05 000 353
E1066	O Ring Silicone Rubber, 25mm x 2mm	1	03 654 629
E1067	O Ring Viton Rubber, 4.5mm x 1.5mm	1	05 000 249
E1067-10	O Ring Viton Rubber, 4.5mm x 1.5mm pack of 10	10	05 000 249
E1069	O Ring Viton Rubber, 7.5mm x 2.5mm	1	05 000 416
E1069-10	O Ring Viton Rubber, 7.5mm x 2.5mm pack of 10	10	05 000 416
E1070	O Ring Viton Rubber, 9.19mm x 2.62mm	1	05 000 359
E1070-10	O Ring Viton Rubber, 9.19mm x 2.62mm pack of 10	10	05 000 359
E1072	O Ring Viton Rubber, 18mm x 2mm	1	05 000 096
E1073	O Ring Viton Rubber, 20mm x 2mm	1	03 654 627
E1073-10	O Ring Viton Rubber, 20mm x 2mm pack of 10	10	03 654 627
E1074	O Ring Viton Rubber, 22mm x 2mm	1	05 000 095
E1074-10	O Ring Viton Rubber, 22mm x 2mm pack of 10	10	05 000 095
E1076	O Ring Viton Rubber, 24mm x 3mm	1	05 000 371
E1077	O Ring Viton Rubber, 38mm x 2.5mm	1	05 000 372
E1082	O Ring Silicone Rubber, 4mm x 4mm	1	03 654 701
E1083	O Ring Silicone Rubber, 4.5mm x 1.5mm	1	05 000 248
E1085	O Ring Silicone Rubber, 6mm x 2mm	1	03 653 118
E1171	O Ring for gripper arm, 7mm x 1.5mm	1	03 002 395
E1172	O Ring, 32mm x 3mm	1	03 002 268
E1173	O Ring, 5mm x 1.5mm	1	05 000 425
E1175	O Ring, 16mm x 3mm	1	05 000 568
E1175-10	O Ring, 16mm x 3mm pack of 10	10	05 000 568
E1176	O-Ring Viton, 8mm x 2mm	1	03 002 850
E1555	Shaft Seal – gripper arm holder	1	03 002 607
E1556	O-ring for Spring Flange, 18mm x 2.5mm	1	05 001 05



E1555



E1556



## Macro CN/CHN/CNS/N-Protein analysis

## Other operating supplies



Absorbent/filter discs 14.5mm  
E2109



Distance ring  
C3048

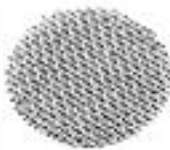

Wire mesh ronde 22mm  
C3036

Stainless steel Sicapent  
ladle with 300mm handle  
E2001

Cat No	Description	Pack	Elementar part
E2109	Absorbent/Filter Discs 14.5mm	100	
E2520	Brass Brush	1	05 001 432
X6000	Consumable kit - vario MAX CHN 2000 samples Kit		25.00-5042
X6002	Consumable kit for 4000 solid sample analysis, vario MACRO cube (CHN CN N)		20.00-5013
E2516	Cotton Wool	50g	05 001 715
C3048	Distance ring	1	12.01-1032/4
E1174	Filter Diameter 18mm	1	03 002 399
E1174-10	Filter Diameter 18mm, pack of 10	10	03002399
E2016	Forceps Stainless Steel Curved Points	1	03 001 248
E2517	GL 14 screw cap	1	05 000 049
E2518	GL 18 Cap	1	05 000 044
E2519	GL25 Cap	1	05 000 046
E2505	Gloves Pair	pair	05 000 094
E2515	Gripper Arm With O Rings for vario MAX N/CN/CHN	1	25.00-0029
E2523	Gripper arm with O Rings for vario MAX cube all modes	1	29.00-0029
E2522	Gripper arm with O-rings For vario MAX in CNS mode	1	25.20-0004
E2537	Manual press 10.5mm pellet diameter	1	41.01-0002/4
E2535	Manual press 7mm pellet diameter	1	41.01-003/4
E2536	Manual press 9mm pellet diameter	1	41.01-0004
E2521	Manually operated drill	1	11.00-0500/4
E2527	Powder filling funnel (large) with silicone tubing outlet	1	
E2526	Powder filling funnel (small) with silicone tubing outlet	1	34.00-0051/4
E2252	Scoop for Tungsten (Elementar reduction tubes) for use with B1203/B1205/B1210 part numbers	1	
E2533	Set of ball valve half shells 14mm	1 set	21.00-0008
E2531	Set of ball valve half shells Rapid N	1 set	12.01-0057
E2530	Set of ball valve half shells vario EL, vario Macro	1 set	11.00-0053
E2039	Snoop Leak Detection Fluid 236ml/8 fluid oz	236ml	
E2291	Spatula Micro Spoon Formed Bent	1	03 950 005
E2251	Stainless Steel Gauze Spacers Tungsten System (Bulk Pack)	100	
E2250	Stainless Steel Gauze Spacers Tungsten System	25	12.01-1008/4
E2001	Stainless Steel Sicapent Ladle with 300mm handle	1	
E2240	Vacuum Grease	50g	03 968 006
C3035	Wire Mesh Ronde 18mm	1	12.00-1005/4
C3036	Wire Mesh Ronde 22mm	1	12.00-1004/4
C3036-10	Wire Mesh Ronde 22mm pack of 10	10	12001004/4
C3046	Wire Mesh Ronde 26.8mm	1	50 008 449/4



Set of ball valve half shells  
E2530

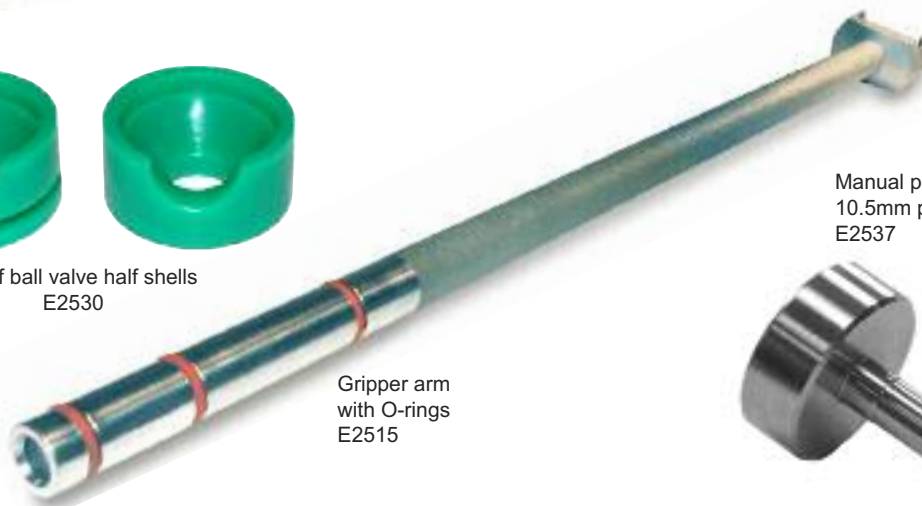

Gripper arm  
with O-rings  
E2515



Manual press  
10.5mm pellet diameter  
E2537

# Chemical supplies

## Macro CN/CHN/CNS/N-Protein analysis

Cat No	Description	Pack	Leco® part
B1163	Aluminium Oxide Pellets	200g	502-188
B1186	Combustion Aid for Liquids	454g	501-427
B1185	Combustion Aid for Solids	454g	501-426
B1184	Combustion Catalyst	250g	502-321
B1136	Copper Turnings Extra Fine Long Strands Reduced & Annealed	100g	501-621
B1107	Copper Turnings Fine Long Strands Reduced & Annealed	200g	501-621
B1015M	Copper Wires Fine Wires Reduced 4 x 0.5mm	100g	502-189
B1212M	Copper Wires Fine Wires Reduced 4 x 0.5mm	1kg	
B1083M	Copper Wires Pound Pack Fine Wires Reduced 4 x 0.5mm	454g	502-304-500
⚠ B1161	EMADrone Magnesium Perchlorate	454g	501-171
⚠ B1162	EMASorb A Granular 0.8 to 1.6mm 14 to 25 mesh	500g	502-174
⚠ B1164	EMASorb B Granular 1.6 to 3mm 7 to 14 mesh	500g	502-176
B1527	F/Cl Trap Material	225g	769-610
⚠ B1191	Furnace Reagent	100g	501-609
B1166	Glass Wool Borosilicate Fibres	454g	501-081
B1167	Glass Wool Borosilicate Fibres	227g	763-265
B1266	Glass Wool Rope Borosilicate Fibres	454g	501-081
B1267	Glass Wool Rope Borosilicate Fibres	227g	763-265
B1269	Halogen Scrubber	50g	502-351
B1526	Halogen Trap Material	200g	769-608
B1195	Iron Chip Accelerator	908g	501-077
B1165	Iron Wool Grade #2	450g	502-310
B1190	Magnesium Oxide Beads	200g	502-359
B1061	Nitrogen Catalyst Pellets	50g	502-049
B1139	Platinised Alumina 1% Pt Granular 0.85 to 1.2mm	50g	
B1522	Quartz Wool Wadding	200g	501-608
B1192	Silica (Quartz) Wool Strips	10	608-379
B1102	Silica (Quartz) Wool Very Fine	50g	502-177
⚠ B1217	Tungsten (VI) Oxide Granular	60g	502-181
B1299	Tungsten (VI) Oxide Granular	300g	11.02-0008
B1187	Vanadium Pentoxide Accelerator	250g	501-636



Aluminium oxide pellets  
B1163



Nitrogen catalyst pellets  
B1061



Combustion aid for solids  
B1185

EMASorb A granular  
0.8 to 1.6mm 14 to 25 mesh  
B1162



Silica (quartz) wool strips  
B1192

⚠ These products are classified as dangerous for shipping

### We support the following Macro analysers from Leco®:

**Leco 528 series**

**Leco 628 series**

**Leco 828 series**

**Leco 928 series**

**Leco CHN600/800**

**Leco CHN1000/CNS1000**

**Leco CHN2000**

**Leco CNS/NS/CN2000**

**Leco TruSpec CHN/CN**

**Leco TruMac**

Please contact us for a Product Sheet specifically for your analyser, or use Advanced Search on our website and select the analyser you require.

For our extensive range of reference materials, see pages 20 – 23.

Do you want to find a product using the manufacturer part number?  
— Use the cross reference lists, beginning on page 24.

Iron wool grade #2  
B1165





Ceramic crucible  
C4034



Ceramic crucibles  
C4039



Porous crucible  
C4065



Ceramic boats unglazed  
C4038



Ceramic boat liner nickel  
50 x 15 x 8 mm  
D5300



Smooth wall tin capsules  
round base 18 x 5 mm  
D4003



Smooth wall tin capsules  
round base 20 x 8 mm  
D4009



Tin foil cones  
standard weight  
D9001



Copper capsules  
part round base 6 x 18 mm  
D4100

Cat No	Description	Pack	Leco® part
D9005	Cel Capsules Medium	400	502-382
D9004	Cel Capsules Small	400	502-338
D5300	Ceramic Boat Liner Nickel 50 x 15 x 8mm	100	502-343
C4038	Ceramic Boats Unglazed	50	529-203
C4036	Ceramic Boats Unglazed	100	529-203
C4137	Ceramic Boats Unglazed	250	528-203-250
C4136	Ceramic Boats Unglazed	500	529-203-500
C4034	Ceramic Crucible	10	501-045-125
C4039	Ceramic Crucibles	50	529-026
D4100	Copper Capsules Part Round Base 6 x 18mm	100	501-571
C4046	Crucible Transparent Silica	50	UK-7753
D8012	Evaporating Foil Cups Tin Capacity 5ml 28 x 24mm diameter	48	UK-338
C4071	Large crucible for liquid	10	617-605
C4065	Porous Crucible	10	614-961-110
D4003	Smooth Wall Tin Capsules Round Base 18 x 5mm	100	501-059
D4015	Smooth Wall Tin Capsules Round Base 18 x 6mm	1000	502-040-100
D4007	Smooth Wall Tin Capsules Round Base 18 x 6mm	100	502-040
D4009	Smooth Wall Tin Capsules Round Base 20 x 8mm	100	502-167
D9001	Tin Foil Cones Standard Weight	100	502-186-200
D9010	Tin Foil Cones Standard Weight	1500	502-186-100
D9002	Tin Foil Cones, Large, Standard Weight	100	502-397
D9003	Tin Foil Cones, Large, Standard Weight	400	502-397-400

# Quartz, glassware & furnace tubes

Macro CN/CHN/CNS/N-Protein analysis

Cat No	Description	Pack	Leco® part
C4336	Anhydron Tube (Large)	1	783-608
C4032	Bubble/Filter/Reagent Tube Borosilicate Glass	1	771-030
C4023	Catalyst Heater Tube Transparent Silica	1	601-437
C4123	Catalyst Heater Tube Transparent Silica pack of 5	5	601-437B
C4027	Filling Funnel Borosilicate Glass	1	502-023
C4342	Filter tube	1	618-809
C4037	Furnace Filter Tube Borosilicate Glass	1	601-390
C4345	Glass tube TruSpec	1	619-425
C4068	Oxygen Lance CHN1000	1	783-278
C4063	Oxygen Lance CNS/CHN-1000	1	608-339
C4051	Oxygen Lance Long (Lance length 5.25)	1	616-146
C4066	Oxygen Lance Short (lance length 4.75)	1	614-962
C4025	Oxygen Lance Transparent Silica	1	776-283
X3000	Prepacked Catalyst Heater/Reduction Tube Leco Transparent Silica	1	
X3010	Prepacked Combustion Tube Leco FP528	1	
C4005	Reagent/Filter Tube Borosilicate Glass	1	775-880
C4332	Reagent Tube	1	617-548
C4004	Reagent Tube Borosilicate Glass	1	775-601
C4043	Reagent Tube Borosilicate Glass	1	606-327
C4020	Reduction Tube Transparent Silica	1	780-911
C4339	Reduction Tube Truspec	1	619-154
C4341	Tube TruSpec	1	619-268



X3000



C4027

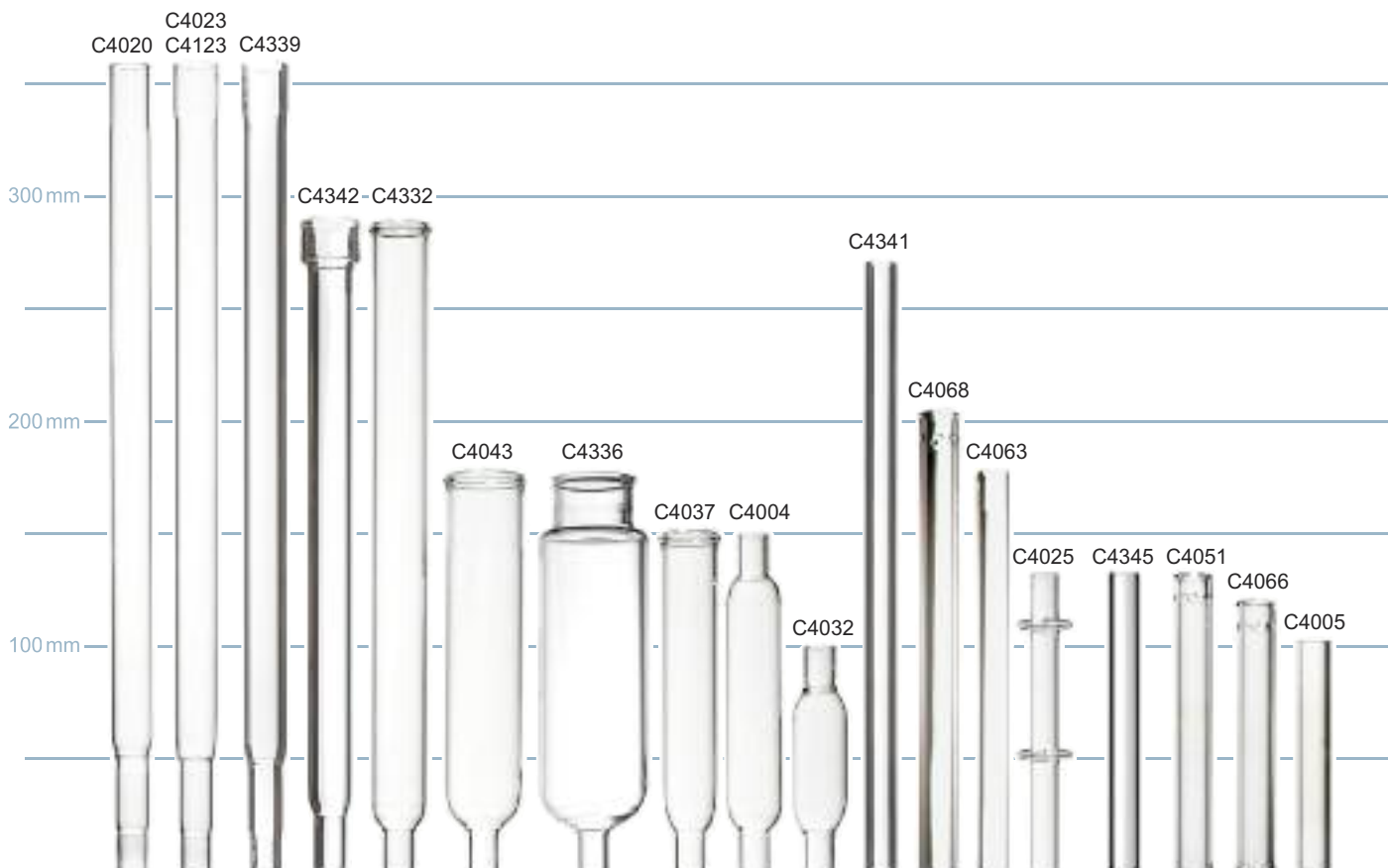

# Quartz, glassware & furnace tubes



Cat No	Description	Pack	Leco® part
C4040	Ceramic Stop	1	606-308
C4057	Combustion Tube FP-528	1	616-108
C4331	Combustion tube CHN 600	1	776-286
C4338	Combustion Tube Truspec/FP628	1	619-065
C4330	Combustion U Tube CHN 800	1	601-132
C4058	Honeycomb Ceramic	1	780-899
C4042	Inner Combustion Tube Ceramic	1	606-313
C4059	Inner Combustion Tube Ceramic CNS1000	1	608-505
C4053	Inner Combustion Tube Silica CHN-1000	1	608-342
C4056	Lance Tube Drilled	1	616-632
C4041	Outer Combustion Tube Ceramic	1	606-309
C4052	Outer Combustion Tube Ceramic CHN-1000	1	608-344
X3015	Prepacked Reaction Tube Leco Truspec	1	
X3010	Prepacked Combustion Tube Leco FP528	1	

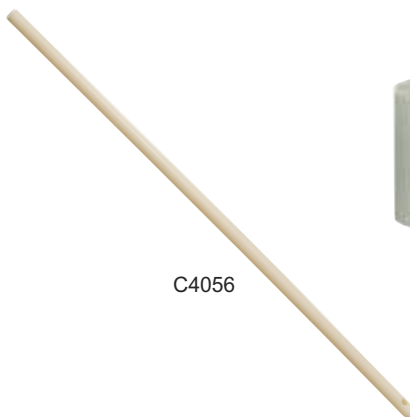

C4058



C4040

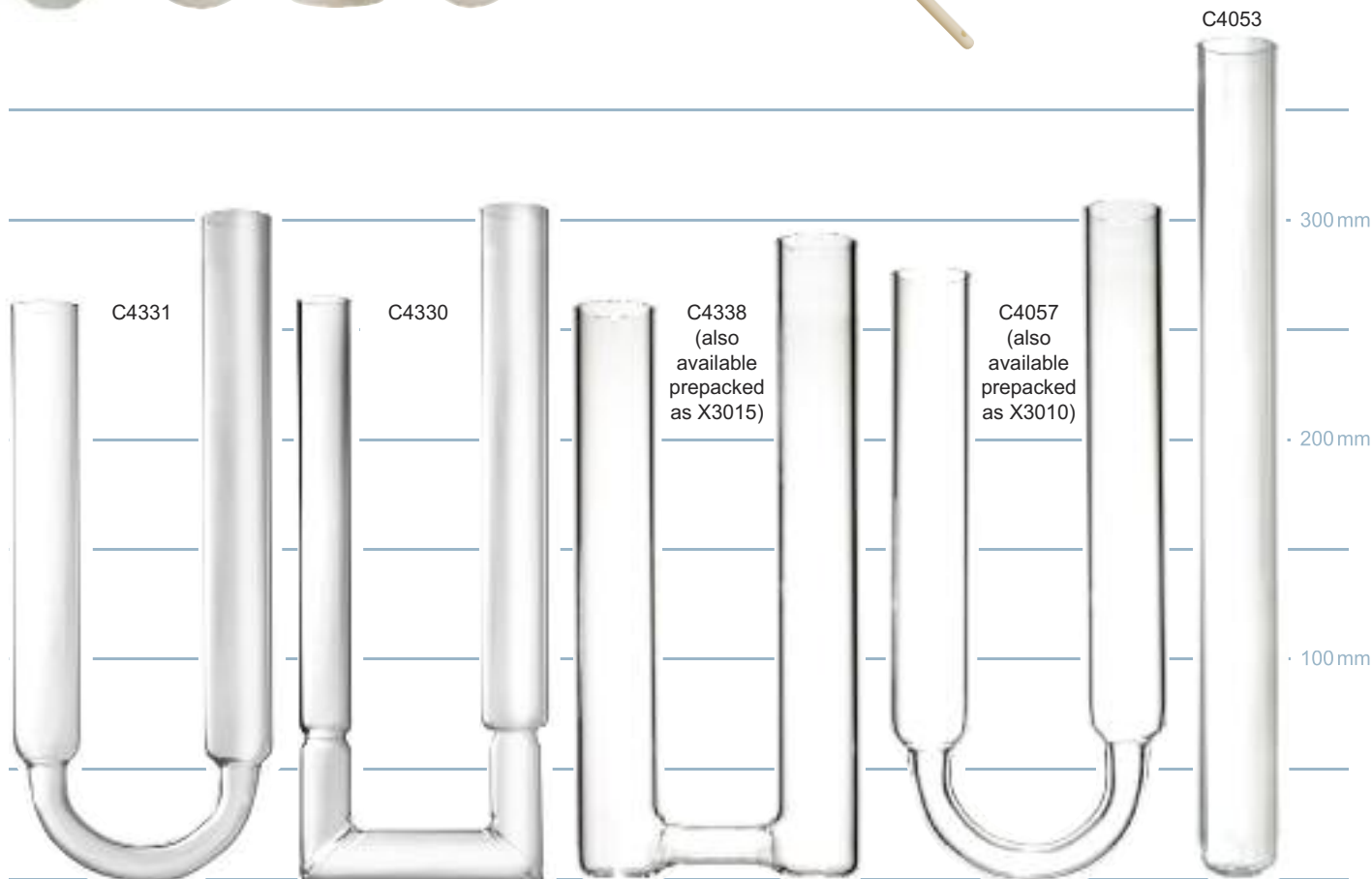

# O-rings & seals

Macro CN/CHN/CNS/N-Protein analysis

O-rings  
are shown  
actual size

Cat No	Description	Pack	Leco® part
E1100	O Ring Sample Drop Block 18.7mm x 2.6mm	1	772-910
E1101	O Ring Catalyst Heater Tube 14.0mm x 2.6mm	1	601-442
E1102	O Ring 4.7mm x 1.4mm	1	601-939
E1103	O Ring Sample Drop Block 68.0mm x 2.6mm	1	601-504
E1105	O Ring Combustion/Catalyst/Filter Tube 6.0mm x 2.6mm	1	605-828
E1107	O Ring Condensing Block 44.2mm x 1.8mm	1	763-379
E1109	O Ring Doser Valve Assembly 2.9mm x 1.8mm	10	772-269
E1110	O Ring 6.0mm x 2.6mm	1	772-520
E1111	O Ring Catalyst Heater Assembly 6.1mm x 1.8mm	1	772-738
E1112	O Ring Sample Drop Block 21.9mm x 2.6mm	1	589-551
E1113	O Ring Reagent Tube 26.7mm x 2.6mm	1	773-141/773-320
E1114	O Ring Sample Drop Block 4.5mm x 1.8mm	1	771-040
E1115	O Ring Combustion Tube 31.3mm x 3.5mm	1	776-284
E1116	O Ring Ballast Tank 145.7mm x 3.5mm	1	778-116
E1117	O Ring Combustion System 5.3mm x 1.8mm	1	606-333
E1118	O Ring Combustion System 44.1mm x 2.6mm	1	611-431
E1119	O Ring Inner Combustion Tube 40.7mm x 5.3mm	1	606-312/608-378/611-476
E1120	O Ring Outer Combustion Tube 53.3mm x 5.3mm	1	606-310/611-477
E1121	O Ring Combustion System 7.6mm x 1.8mm	1	760-841
E1122	O Ring Precooler Assembly 34.7mm x 1.8mm	1	771-991
E1123	O Ring Combustion System 50.5mm x 2.6mm	1	774-489
E1124	O Ring Combustion System 44.1mm x 2.6mm	1	775-314
E1125	Neoprene Gasket Ballast Seal 160mm x 150mm x 3mm	1	778-120
E1131	O Ring Catalyst Heater Tube 10.8mm x 2.6mm	1	778-114
E1133	O Ring Filter Tube 15.5mm x 3.5mm	1	765-976
E1134	Radial shaft seal autoloader 7.6mm x 2.6mm	1	609-271
E1139	O-Ring Lance Assembly FP528 17.2mm x 1.8mm	2	780-831
E1140	O-Ring Combustion Tube FP528/628 36.1mm x 3.5mm	1	616-138
E1311	O Ring 17.1mm x 2.6mm	1	771-407
E1328	O-Ring 47.0mm x 5.3mm	1	783-190/783-897
E1329	O-Ring 37.5mm x 5.3mm	1	783-189
E1342	O Ring 41.0mm x 2.6mm	1	774-425
E1344	O Ring 31.4mm x 2.6mm	1	601-684
E1345	O Ring 5.2mm x 2.6mm	1	617-136
E1357	O Ring 34.6mm x 2.6mm	1	612-340
E1358	O Ring 25.1mm x 2.6mm	1	619-139
E1359	O Ring 56.9mm x 1.8mm	1	619-192
E1360	O ring 29.8mm x 2.6mm	1	702-557



O-rings & seals

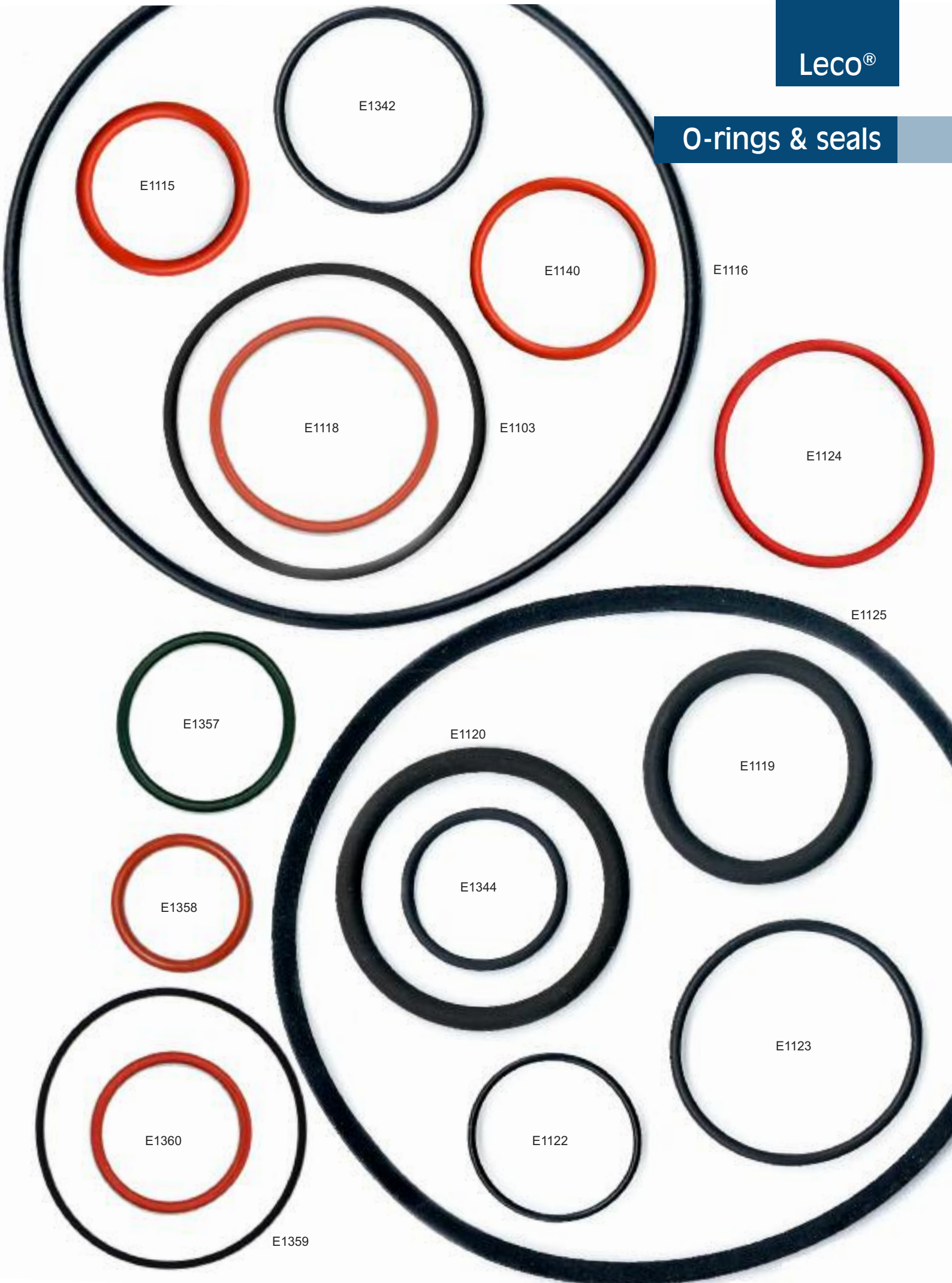



## Other operating supplies

Macro CN/CHN/CNS/N-Protein analysis

Cat No	Description	Pack	Leco® part
E2768	Boat Puller Assembly	1	501-062
E2736	Braided Cable	1	606-319
E2772	Braided Cable (short strap)	1	613-563
E2794	C-Flex Tubing Repl Kit	1	625-602-470/ 625-602-172
E2154	Cleaning Brush	1	601-981
E2170	Cooling Fan 80x80x38mm 115VAC	1	772-992
E2165	Cooling Plate Stainless Steel	1	601-387
E2471	Crucible Tong	1	761-929
E2499	Dosing Valve Stem	1	616-540
E2166	Dosing Valve Stem Stainless Steel Without O Rings	1	601-937
E2745	Fan FP528	1	616-548
E2016	Forceps Stainless Steel Curved Points	1	604-378
E2017	Forceps Stainless Steel Straight Points	1	502-028
C4060	Glass Scoop	1	503-032
E2204	Heating Element Clamp	1	606-320
E2206	Heating Elements Set of 4	4	606-601
E2199	Lance Assembly Complete	1	616-147
E2498	Lance Assembly Complete	1	614-963
E2197	Lance Holder Block	1	783-275
E2198	Lance Holder Cover	1	783-276
E2464	O-Ring Installation Tube	1	603-350
E2244	Paper Roll SC32/132/232	1	770-764
E2369	Particle Filter	1	616-504
E2151	Particle Filter	1	768-980/ 633-101-460
E2150	Pinch Valve Tubing	1ft	601-691
E2183	Pneumatic Cylinder 1 Stroke 3/8 Bore	1	601-876
E2164	PolyFlow Tube 1/4 OD x 1/8 ID	1ft	537-103
E2169	Polyu Tubing 1/8 OD x 1/16 ID	1ft	773-662



Lance assembly complete  
E2199



Lance holder block  
E2197



Particle filter  
E2151

Particle filter  
E2369



Braided cable  
E2772



Braided cable  
E2736

Heating elements  
E2206



Heating element clamp  
E2204



Cleaning brush  
E2154



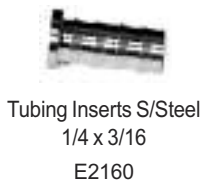

Cat No	Description	Pack	Leco® part
E2152	Printer Paper American Letter 8.5 x 11	600 sheets	601-483
E2153	Printer Ribbon	1	601-484
E2237	Printer Ribbon CHN600/SC32/132/232/CR12	1	770-778
E2380	Screw	1	190-624
E2163	Screw Nylon 6-32 x 1 Slotted Countersunk Head	1	190-865
E2162	Screw S/Steel 6-32 x 0.44 Philips Pan Head	1	190-055
E2185	Screw Zinc Plate 6-32x0.25 Philips Countersunk (Loading Head)	1	190-427
E2201	Screws For Lance Assembly FP-528	4	190-423
E2238	Seal Piston FP228 328 428 528 CHN1000/CNS1000	1	601-883
E2235	Secondary (screen) Filter	1	775-306
E2158	Silicone Grease	100g	501-241
E2039	Snoop Leak Detection Fluid	236ml	502-213
E2462	Spatula	1	501-614
E2167	Spring - Dosing Valve Assembly	1	602-672
E2205	Thermocouple SC-432	1	606-224
E2182	Tube Fitting Brass 10/32 to 1/16 ID tube	1	773-661
E2181	Tube Fitting White Nylon 1/8 NPT to 3mm ID tube	1	602-605
E2160	Tubing Inserts S/Steel 1/4 x 3/16	1	163-020
E2161	Tubing PTFE 1/4 OD x 3/16 ID 172-505	1ft	172-505
E2196	Valve Block	1	601-936

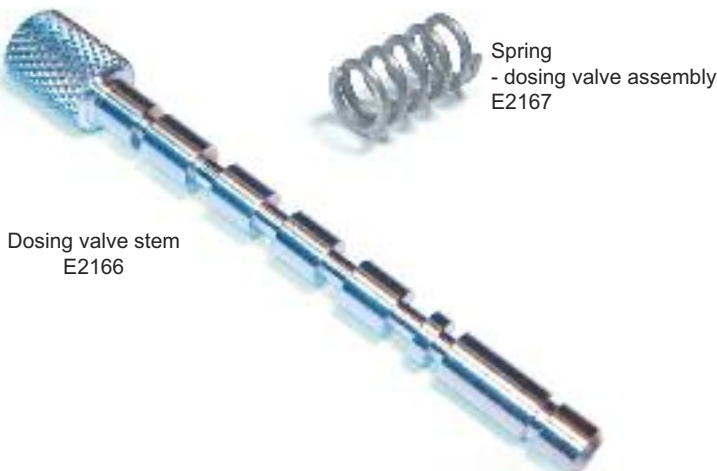

## Reference materials

Macro CN/CHN/CNS/N-Protein analysis

### Natural reference materials

Cat No	Description	Pack	%C	%H	%N	%O	%S
B2273	Alfalfa Organic Analytical Standard	30g	42.78	5.79	2.52		0.25
B2164	Algae (Bladderwrack) Standard	30g	33.67	4.92	1.25		2.29
B2162	Algae (Spirulina) Standard	30g	46.47	6.88	10.75		0.78
B2277	Barley Flour Organic Analytical Standard	30g	43.51	6.00	1.90		0.14
B2166	Birch leaf Standard	30g	48.09	6.55	2.12		0.17
B2160	Chitin Standard	30g	42.72	6.49	6.25	37.84	
B2168	Coconut shell Standard	30g	49.04	6.01	0.09		
B2272	Corn Gluten Organic Analytical Standard	30g	45.27	5.98	10.38		0.85
B2270	Corn Meal Organic Analytical Standard	30g	45.52	6.30	1.15		0.10
B2152	Low Organic Content Soil Standard OAS	30g	1.56		0.13		0.02
B2178	Medium Organic Content Soil Standard OAS	30g	3.07		0.27		0.04
B2150	High Organic Content Sediment Standard OAS	30g	7.45		0.52		0.62
B2276	Oatmeal Organic Analytical Standard	30g	47.00	6.67	2.03	42.10	0.16
B2170	Olive stone Standard	30g	47.06	6.35	0.20		
B2141	Orchard Leaves Standard	20g	49.54	6.24	2.31		0.44
B2140	Pasta Standard	10g			2.14		
B2149	Pasta Standard	100g			2.14		
B2154	Protein Standard OAS (Certified for Nitrogen only)	30g			13.32		
B2278	Rice Flour Organic Analytical Standard	30g					0.14
B2275	Rye Flour Organic Analytical Standard	30g					0.13
B2196	Set of 6 soil standards Contains 1 of each of the following B2176, B2180, B2182, B2184, B2186, B2188						
B2188	Soil Standard (Chalky)	30g	4.57		0.38		
B2184	Soil Standard (Clay)	30g	2.29		0.21		(0.03)
B2186	Soil Standard (Loamy)	30g	2.75		0.27		(0.04)
B2176	Soil Standard (Peaty)	30g	15.95		1.29		(0.43)
B2180	Soil Standard (Sandy)	30g	0.83		0.07		(0.01)
B2182	Soil Standard (Silty)		2.19		0.18		(0.03)
B2158	Sorghum Flour Standard OAS	30g	41.26		1.47		0.10
B2271	Soy Bean Meal Organic Analytical Standard	30g	45.24	5.73	7.89		0.42
B2209	Bitumen-Asphalt CHNOS standard	30g	84.41	10.06	3.21	1.26	0.27
B2274	Wheat Flour Organic Analytical Standard	30g	38.86	5.45	1.81		0.13
B2156	Wheat Flour Standard OAS	30g	39.94		1.45		0.10

Analysis values may change depending on the current batch available; please see the website or contact us for information on the current analysis values of reference materials.

## Pure chemical reference materials

Cat No	Description	Pack	%C	%H	%N	%O	%S
B2049	25-(Bis(5-tert-butyl-2-benzo-oxazol-2-yl) thiophene (BBOT) OAS	25g	72.56	6.11	6.49	7.41	7.40
B2118	3,5-Dinitrobenzoic Acid OAS	5g	39.66	1.81	13.28	45.26	
B2122	Acetanilide OAS	25g	71.06	6.71	10.31	11.82	
B2114	Acetanilide OAS	5g	71.06	6.71	10.31	11.82	
B2212	Ammonium Chloride Standard	5g			26.12		
B2211	Ammonium sulphate standard	5g			21.14		
B2138	Aspartic Acid OAS	100g	36.13	5.34	10.54		
B2139	Aspartic Acid OAS	10g	36.13	5.34	10.54		
B2006	Atropine OAS	10g	70.56	8.03	4.80	16.54	
B2104	Caffeine OAS	5g	49.48	5.16	28.83	16.47	
B2250	Calcium Carbonate	50g	12.00				
B2105	Cystine OAS	5g	29.95	5.09	11.59	26.67	26.67
B2146	Ethylenediaminetetra-acetic Acid (EDTA)	50g	41.15	5.52	9.54	43.69	
B2144	Ethylenediaminetetra-acetic Acid (EDTA)	500g	41.08	5.51	9.60		
B2137	Ethylenediaminetetra-acetic Acid (EDTA) OAS	100g	41.08	5.51	9.60		
B2115	Ethylenediaminetetra-acetic Acid (EDTA) OAS	50g	41.08	5.51	9.60		
B2120	Ethylenediaminetetra-acetic Acid (EDTA) OAS	25g	41.15	5.52	9.54	43.69	
B1405	Glutamic acid OAS	250g	40.79	6.14	9.47		
B2100	Methionine OAS	25g	40.31	7.45	9.34	21.49	21.51
B2101	Methionine OAS Nitrogen Only	50g	40.25	7.43	9.35		
B2148	Phenylalanine OAS	25g	65.44	6.71	8.48	19.37	
B2210	Potassium Nitrate Standard	5g			13.72		
B2102	Stearic Acid OAS	5g	76.00	12.75		11.25	
B2121	Sucrose OAS	25g	42.10	6.48		51.41	
B2106	Sulphamethazine OAS	5g	51.78	5.07	20.12	11.49	11.52
B2107	Sulphamethazine OAS	25g	51.78	5.07	20.12	11.49	11.52
B2147	Sulphanilic Acid OAS	5g	41.71	4.03	8.00	27.64	18.54
B2142	Tryptophan OAS	100g			13.72		
B2130	Urea OAS	10g	20.00	6.71	46.64	26.64	
B2119	Urea OAS	25g	20.00	6.71	46.64	26.64	
B2260	Zinc Sulphide Standard	50g					32.90

Analysis values may change depending on the current batch available; please see the website or contact us for information on the current analysis values of reference materials.

## Reference materials

### Macro CN/CHN/CNS/N-Protein analysis

#### Coal and coke standards

Cat No	Description	Pack	%C	%H	%N	%O	%S
B2320	Coal CHNS Standard (S~0.25%) CRM	50g	69.38	4.59	0.93	17.91	0.39
B2321	Coal CHNS Standard (S~0.75%) CRM	50g	80.96	4.99	1.62	4.27	0.93
B2322	Coal CHNS Standard (S~2%) CRM	50g	41.49	3.08	0.75	5.58	2.01
B2323	Coal CHNS Standard (S~3%) CRM	50g	60.98	4.16	1.09	6.47	3.61
B2324	Coal CHNS Standard (S~6%) CRM	50g	55.70	4.10	1.28	9.89	5.39
B2325	Coal Standard CHNS CRM Set contains 1 each of the following B2320, B2321, B2322, B2323, & B2324						
B2300	Coal Standard Sulphur Range 0.35%	50g					0.35
B2301	Coal Standard Sulphur Range 0.57%	50g					0.57
B2302	Coal Standard Sulphur Range 0.7%	50g					0.73
B2303	Coal Standard Sulphur Range 0.89%	50g					0.89
B2304	Coal Standard Sulphur Range 1.09%	50g					1.09
B2305	Coal Standard Sulphur Range 1.48%	50g					1.48
B2306	Coal Standard Sulphur Range 2.07%	50g					2.07
B2307	Coal Standard Sulphur Range 2.63%	50g					2.63
B2308	Coal Standard Sulphur Range 3.03%	50g					3.03
B2309	Coal Standard Sulphur Range 3.79%	50g					3.79
B2310	Coal Standard Sulphur Range 4.1%	50g					4.10
B2311	Coal Standard Sulphur Range 5.59%	50g					5.59
B2312	Coal Standard Sulphur Range 5.79%	50g					5.79
B2318	Coke CHNS Standard (S~4%) CRM	50g	88.78	2.05	1.18		3.51
B2317	Coke Standard Sulphur Range 0.47%	50g					0.47
B2315	Coke Standard Sulphur Range 0.61%	50g					0.61
B2316	Coke Standard Sulphur Range 1.21%	50g					1.21
B2339	Sulfur in Coal CRM (S=1.18%)	50g					1.18
B2340	Sulfur in Coal CRM (S=1.71%)	50g					1.71
B2341	Sulfur in Coal CRM (S=7.06%)	50g					7.06
B2342	Sulfur in Green Petroleum Coke (S= 0.43%)	50g					0.43
B2343	Sulfur in Green Petroleum Coke (S= 0.49%)	50g					0.49
B2344	Sulfur in Green Petroleum Coke (S= 0.906%)	50g					0.906
B2345	Sulfur in Green Petroleum Coke (S= 1.20%)	50g					1.20
B2346	Sulfur in Green Petroleum Coke (S= 2.47%)	50g					2.47
B2347	Sulfur in Green Petroleum Coke (S= 2.21%)	50g					2.21
B2348	Sulfur in Green Petroleum Coke (S= 2.58%)	50g					2.58
B2349	Sulfur in Green Petroleum Coke (S= 4.34%)	50g					4.34
B2386	Sulfur in Green Petroleum Coke (S= 5.56%)	50g					5.56
B2313	Ultra Low Sulphur Coal Standard Sulphur Range 0%	50g					0.00
B2314	Ultra Low Sulphur Coal Standard Sulphur Range 0.03%	50g					0.03
B2326	Ultra Low Sulphur Coal Standard Sulphur Range 0.049%	50g					0.05
B2327	Ultra Low Sulphur Coal Standard Sulphur Range 0.098%	50g					0.10
B2328	Ultra Low Sulphur Coal Standard Sulphur Range 0.164%	50g					0.16

Analysis values may change depending on the current batch available; please see the website or contact us for information on the current analysis values of reference materials.

### Proximate coal standards

Cat No	Description	Pack	% S	% Ash	% Vol. matter	BTU	Fixed C
B2801	Proximate Coal CRM	50g	0.39	6.80	42.12	11713	51.08
B2802	Proximate Coal CRM	50g	0.52	5.03	29.48	12572	65.49
B2803	Proximate Coal CRM	50g	0.93	7.23	31.33	114392	61.44
B2804	Proximate Coal CRM	50g	1.20	6.67	42.29	12937	51.04
B2805	Proximate Coal CRM	50g	1.42	17.26	32.27	12216	50.47
B2806	Proximate Coal CRM	50g	2.01	47.09	23.47	7409	29.44
B2807	Proximate Coal CRM	50g	2.34	21.38	28.07	11645	50.51
B2808	Proximate Coal CRM	50g	2.95	7.69	39.35	12357	52.96
B2809	Proximate Coal CRM	50g	3.62	23.69	27.06	10892	49.25
B2811	Proximate Coal CRM	50g	1.80	41.64	26.39	8377	31.97
B2812	Proximate Coal CRM	50g	6.26	13.09	38.18	10686	48.73
B2813	Proximate Coal CRM	50g	0.55	17.58	6.08	11990	76.34
B2814	Proximate Coal CRM	50g	0.61	7.56	36.31	13181	56.13

### Petroleum and fuel standards

Cat No	Description	Pack	%C	%H	%N	%O	%S
B2336	Extreme Pressure Oil Sulphur Range 2%	100ml					2.00
B2337	Extreme Pressure Oil Sulphur Range 3%	100ml					3.30
B2338	Extreme Pressure Oil Sulphur Range 4%	100ml					4.19
B2331	High Sulphur Residual Oil Sulphur Range 20%	100ml					20.00
B2330	High Sulphur Residual Oil Sulphur Range 30%	100ml					30.00
B2334	High Sulphur Residual Oil Sulphur Range 5%	100ml					5.00
B2333	High Sulphur Residual Oil Sulphur Range 5.78%	100ml					5.78
B2332	High Sulphur Residual Oil Sulphur Range 9.86%	100ml					9.86
B2364	Residual Oil Standard Sulphur Range 0.048%	100ml					0.48
B2360	Residual Oil Standard Sulphur Range 0.1065%	100ml					0.13
B2358	Residual Oil Standard Sulphur Range 0.15%	100ml					0.15
B2361	Residual Oil Standard Sulphur Range 0.2%	100ml					0.21
B2362	Residual Oil Standard Sulphur Range 0.3%	100ml					0.30
B2359	Residual Oil Standard Sulphur Range 0.35%	100ml					0.35
B2363	Residual Oil Standard Sulphur Range 0.4%	100ml					0.42
B2365	Residual Oil Standard Sulphur Range 0.6%	100ml					0.61
B2366	Residual Oil Standard Sulphur Range 0.7%	100ml					0.70
B2367	Residual Oil Standard Sulphur Range 0.8%	100ml					0.82
B2368	Residual Oil Standard Sulphur Range 0.9%	100ml					0.90
B2369	Residual Oil Standard Sulphur Range 1.02%	100ml					1.02
B2370	Residual Oil Standard Sulphur Range 1.5%	100ml					1.49
B2371	Residual Oil Standard Sulphur Range 2.01%	100ml					2.01
B2372	Residual Oil Standard Sulphur Range 2.5%	100ml					2.50
B2373	Residual Oil Standard Sulphur Range 3%	100ml					2.92
B2374	Residual Oil Standard Sulphur Range 3.5%	100ml					3.46
B2375	Residual Oil Standard Sulphur Range 4%	100ml					4.00
B2376	Residual Oil Standard Sulphur Range 4.5%	100ml					4.50

Analysis values may change depending on the current batch available; please see the website or contact us for information on the current analysis values of reference materials.

## Cross references

### Macro CN/CHN/CNS/N-Protein analysis

Elementar® part	Description	Pack	Cat. No.
03 001 118	Sulphanilic Acid OAS	5g	B2147
03 001 248	Forceps Stainless Steel Curved Points	1	E2016
03 002 262	Platinum Catalyst 5% Pt	30g	B1196
03 002 262	Platinum Catalyst 5% Pt	150g	B1308
03 002 268	O Ring, 32mm x 3mm	1	E1172
03 002 278	Metal crucibles	100	C3064
03 002 395	O Ring for gripper arm	1	E1171
03 002 399	Filter Diameter 18mm	1	E1174
03 002 399	Filter Diameter 18mm	10	E1174-10
03 002 607	Shaft Seal	1	E1555
03 002 850	O-Ring Viton, 8mm x 2mm	1	E1176
03 653 118	O Ring Silicone Rubber	1	E1085
03 654 627	O Ring Viton Rubber, 20mm x 2mm	1	E1073
03 654 627	O Ring Viton Rubber, 20mm x 2mm	10	E1073-10
03 654 629	O Ring Silicone Rubber, 25 x 2mm	1	E1066
03 654 701	O Ring Silicone Rubber, 4mm x 4mm	1	E1082
03 679 900	EMASorb A Granular 0.8 to 1.6mm 14 to 25 mesh CO2 Absorbant	200g	B1115
03 679 900	EMASorb A Granular 0.8 to 1.6mm 14 to 25 mesh	500g	B1162
03 679 901	EMADrone Magnesium Perchlorate	454g	B1161
03 679 905	Copper Oxide Wires (Coarse) Coarse wires 6 x 0.65mm	250g	B1218
03 679 907	Silica (Quartz) Chips Granular 1 to 2mm	100g	B1214
03 679 908	Silica (Quartz) Wool Very Fine	10g	B1208
03 679 915	Cerium Dioxide Granular	100g	B1219
03 679 942	Acetanilide OAS	5g	B2114
03 950 005	Spatula Micro Spoon Formed Bent	1	E2291
03 960 352	Sicapent	30g	B1297
03 960 352	Sicapent (2.8L)	500g	B1197
03 968 006	Vacuum Grease	50g	E2240
03002262	Platinum Catalyst 5% Pt	150g	B1308
03960352	Sicapent	30g	B1297
05 000 044	Cap GL 18	1	E2518
05 000 046	Cap GL 25	1	E2519
05 000 049	GL 14 Screw cap	1	E2517
05 000 086	Alumina (Aluminium Oxide) Wool Fine	20g	B1089
05 000 087	Ash Finger Ceramic rapid N	1	C3030
05 000 088	Oxygen Lance 140mm	1	C3011
05 000 094	Gloves	1 Pair	E2505
05 000 095	O Ring Viton Rubber, 22mm x 2mm	1	E1074
05 000 095	O Ring Viton Rubber, 22mm x 2mm	10	E1074-10
05 000 096	O Ring Viton Rubber, 18mm x 2mm	1	E1072
05 000 247	Seal for Oxygen lance viton rubber	1	E1050
05 000 247	Seal for Oxygen lance viton rubber	10 (1m)	E1050-10
05 000 248	O Ring Silicone Rubber	1	E1083
05 000 249	O Ring Viton Rubber, 4.5mm x 1.5mm	1	E1067
05 000 249	O Ring Viton Rubber, 4.5mm x 1.5mm	10	E1067-10
05 000 311	Smooth Wall Tin Capsules Round Base 20 x 8mm	100	D4009
05 000 353	Quadring Viton Rubber, 7.65mm x 1.78mm	1	E1054
05 000 353	Quadring Viton Rubber, 7.65mm x 1.78mm	10	E1054-10
05 000 354	Oxygen Lance 150mm	1	C3012
05 000 359	O Ring Viton Rubber, 9.19mm x 2.62mm	1	E1070
05 000 371	O Ring Viton Rubber, 24mm x 3mm	1	E1076
05 000 372	O Ring Viton Rubber, 38mm x 2.5mm	1	E1077
05 000 416	O Ring Viton Rubber, 7.5mm x 2.5mm	1	E1069
05 000 416	O Ring Viton Rubber, 7.5mm x 2.5mm	10	E1069-10
05 000 425	O Ring, 5mm x 1.5mm	1	E1173
05 000 429	Tin Foil Cones Standard Weight	100	D9001

The use of Elementar® part numbers is intended for convenience only, and does not imply that the products are of Elementar® origin. All Elemental Microanalysis products are guaranteed to be of high quality and are deemed to be suitable alternatives.

## Macro CN/CHN/CNS/N-Protein analysis

## Cross references

The use of Elementar® part numbers is intended for convenience only, and does not imply that the products are of Elementar® origin. All Elementar Microanalysis products are guaranteed to be of high quality and are deemed to be suitable alternatives.

Elementar® part	Description	Pack	Cat. No.
05 000 469	Cerium Dioxide Fused Granular	100g	B1270
05 000 568	O Ring, 16mm x 3mm	1	E1175
05 000 568	O Ring, 16mm x 3mm	10	E1175-10
05 000 658	Oxygen lance 170mm	1	C3013
05 000 699	Copper Wires Fine Wires Reduced 4 x 0.5mm	100g	B1015M
05 000 880	Manganese Dioxide Sulphur Reduction in U-Tube	10g	B1204
05 000 900	Silica (Quartz) Chips Granular 2 to 4mm	50g	B1215
05 001 013	Rapid Caps	190	D1117
05 001 039	Copper Oxide Wires Fine Wires 4 x 0.5mm	250g	B1122
05 001 067	Glutamic acid OAS	250g	B1405
05 001 169	Phenylalanine OAS	25g	B2148
05 001 432	Brass Brush	1	E2520
05 001 715	Cotton Wool	50g	E2516
050 00 359	O Ring Viton Rubber, 9.19mm x 2.62mm	10	E1070-10
05001053	O-ring for Spring Flange, 18mm x 2.5mm	1	E1556
11.00-1170/4	Ash finger	1	C3018
11 001 172/4	Support tube 65mm	1	C3017
11 001 317/4	Protection tube Vario EL	1	C3021
11 001 317/4	Protection tube Vario EL (alt to C3021 without slits)	1	C3059
11.00-0053	Set of ball valve half shells vario EL, vario Macro	1	E2530
11.00-0500/4	Manually operated drill	1	E2521
11.00-1150/4	Combustion/Reduction Tube	1	C3009
11.00-1331/4	Connecting tube transparent silica 65mm (Includes O-rings)	1	C3022
11.00-1363/4	Ash Finger 60mm Stainless Steel	1	C3063
11.00-1364/4	support rod, reduction tube 65mm	1	C3053
11.02-0008	Tungsten (VI) Oxide Granular	60g	B1217
11.02-0017	Tungsten (VI) Oxide Powder Fine Powder	25g	B4013
11.02-0024	Tungsten (VI) Oxide Powder	90g	B4014
11.02-1036/4	Ash finger	1	C3024
11.02-1036/4	Ash finger pack of 10	10	C3070
11.45-1005/4	Ash Finger 90mm Stainless Steel	1	C3062
11.45-1012/4	Oxygen lance 190mm	1	C3014
11001170/4	Ash Finger	10	C3060
11001317/4	Protection tube vario EL	1	C3021
11001317/4	Protection tube Vario EL (alternative to C3021 11001317/4 without slits)	1	C3059
12.00-0040	Tungsten Granulated	500g	B1205
12.00-0040	Tungsten Granulated (Bulk)	2.5 kg	B1210
12.00-1004/4	Wire Mesh Ronde 22mm	1	C3036
12.00-1004/4	Wire Mesh Ronde 22mm	10	C3036-10
12.00-1005/4	Wire Mesh Ronde 18mm	1	C3035
12.00-1087/4	Ash Finger Stainless Steel	1	C3031
12.01-0032	Tin Foil Squares Standard Weight 37 x 37mm	400	D1116
12.01-0045	Tungsten Kit Complete 500g of Tungsten Granulated +25 Stainless Gauzes		B1203
12.01-1008/4	Stainless Steel Gauze Spacers Tungsten System	25	E2250
12.01-1012/4	Tin Foil Squares Standard Weight 50 x 50mm	100	D1115
12.01-1032/4	Distance ring	1	C3048
12.01-1036/4	Combustion Tube S/S (From Serial No. 12991001)	1	C3041
15.00-0080	Drying tube	1	C1143
15.00-1319	Ceramic crucible	1	C3027
15.40-1002	support rod reduction tube 110mm	1	C3057
16.00-1012	Drying tube 348 mm GL25	1	C3026
16.00-1037	Drying tube short	1	C3047
20.00-5013	Consumable kit for 4000 solid sample analysis vario MACRO cube (CHN CN N)	1	X6002
21.00-0008	Set of ball valve half shells 14mm	1	E2533
22 131 365	Silver Wool 0.05mm Fine Wire	50g	B1231
22 160 200/4	Drying Guard Tube Borosilicate Elementar	1	C3008



## Cross references

### Macro CN/CHN/CNS/N-Protein analysis

The use of Elementar® part numbers is intended for convenience only, and does not imply that the products are of Elementar® origin. All Elemental Microanalysis products are guaranteed to be of high quality and are deemed to be suitable alternatives.

The use of Leco® part numbers is intended for convenience only, and does not imply that the products are of Leco® origin. All Elemental Microanalysis products are guaranteed to be of high quality and are deemed to be suitable alternatives.

Elementar® part	Description	Pack	Cat. No.
22 160 204/4	Drying tube with GL14 end caps	1	C3066
23.00-0080	U Tube GL14	1	C3123
23.00-1148	support rod reduction tube 175mm	1	C3052
25 00-1048	Post Combustion Tube	1	C3042
25.00-0017	Quartz Reduction/Tungsten Tube 29mm (From Serial No. 12991001)	1	C3040
25.00-0029	Gripper Arm With O Rings	1	E2515
25.00-0120	Glass connection tube no20	1	C3128
25.00-0121	Glass connection tube no21	1	C3127
25.00-1028	Combustion tube quartz vario MAX	1	C3044
25.00-1030	Combustion Tube	1	C3043
25.00-1123	Ceramic Crucible	100	C3058
25.00-5042	Consumable kit - vario MAX CHN 2000 samples Kit.	1 kit	X6000
25.20-0004	Gripper arm with O-rings For vario MAX in CNS mode	1	E2522
25.20-1003	Connecting tube transparent silica 130mm (Includes O-rings)	1	C3025
29.00-0029	Gripper arm with O Rings for vario MAX cube	1	E2523
29.00-0071	Drying tube	1	C3124
29.00-0092	Zinc granules	50g	B1406
29.00-0092	Zinc granules	200g	B1407
29.00-1030	SS combustion tube vario MAX cube	1	C3055
29.00-1078	Combustion tube quartz	1	C3067
34 001 339/4	U-Tube Large Complete with GL18 Caps	1	C3038
34.00-0051/4	Powder filling funnel (small) with silicone tubing outlet	1	E2526
38.00-0124	Brass wool	50g	B1304
41.01-0002/4	Manual press 10.5mm pellet diameter	1	E2537
41.01-0004	Manual press 9mm pellet diameter	1	E2536
41.01-003/4	Manual press 7mm pellet diameter	1	E2535
50 008 449/4	Wire Mesh Ronde 26.8mm	1	C3046
50 008 467	Alumina (Aluminium Oxide) Spheres 3 to 6mm	50g	B1090
50 009 375/4	Filter tube	1	C3045
88 895 805	Aspartic Acid OAS	100g	B2138

Leco® part	Description	Pack	Cat. No.
163-020	Tubing Inserts S/Steel 1/4 x 3/16		E2160
172-505	Tubing PTFE 1/4 OD x 3/16 ID	FT	E2161
190-055	Screw S/Steel 6-32 x 0.44 Philips Pan Head	1	E2162
190-423	Screws For Lance Assembly FP-528	4	E2201
190-427	Screw Zinc Plate 6-32x0.25 Philips Countersunk (Loading Head)	1	E2185
190-865	Screw Nylon 6-32 x 1 Slotted Countersunk Head	1	E2163
501-001	Coal Standard Sulphur Range 0.35%	50g	B2300
501-005	Coal Standard Sulphur Range 1.09%	50g	B2304
501-014	Coal Standard Sulphur Range 1.48%	50g	B2305
501-015	Coal Standard Sulphur Range 0.89%	50g	B2303
501-020	Coal Standard Sulphur Range 3.03%	50g	B2308
501-022	Coal Standard Sulphur Range 3.79%	50g	B2309
501-034	Calcium Carbonate 12%	50g	B2250
501-045	Crucible Ceramic	10	C4034
501-045-125	Crucible Ceramic	10	C4034
501-046	Sucrose OAS	25g	B2121
501-050	Nicotinic Acid OAS	15g	B2099
501-053	Acetanilide OAS	5g	B2114
501-059	Smooth Wall Tin Capsules Round Base 18 x 5mm	100	D4003
501-062	Boat Puller Assembly	1	E2768
501-077	Iron Chip Accelerator	908g	B1195
501-081	Glass Wool Borosilicate Fibres	454g	B1166
501-081	Glass Wool Rope Borosilicate Fibres	454g	B1266
501-130	Coal Standard Sulphur Range 4.1%	50g	B2310

## Macro CN/CHN/CNS/N-Protein analysis

## Cross references

The use of Leco® part numbers is intended for convenience only, and does not imply that the products are of Leco® origin. All Elemental Microanalysis products are guaranteed to be of high quality and are deemed to be suitable alternatives.

Leco® part	Description	Pack	Cat. No.
501-171	EMADrone Magnesium Perchlorate	454g	B1161
501-171-HAZ	EMADrone Magnesium Perchlorate	454g	B1161
501-184	Coal Standard Sulphur Range 5.13%	50g	B2311
501-241	Silicone Grease	100g	E2158
501-426	Combustion Aid for Solids	454g	B1185
501-427	Combustion Aid for Liquids	454g	B1186
501-441	Sucrose OAS	25g	B2121
501-561	Soy Bean Meal Organic Analytical Standard	30g	B2271
501-571	Copper Capsules Part Round Base 6 X 18mm	100	D4100
501-608	Quartz Wool Wadding	200g	B1522
501-609	Furnace Reagent	100g	B1191
501-614	Spatula	1	E2462
501-621	Copper Turnings Fine Long Strands Reduced and Annealed	200g	B1107
501-636	Vanadium Pentoxide Accelerator	250g	B1187
501-964	Coal Standard Sulphur Range 5.79%	50g	B2312
501-967	Extreme Pressure Oil Sulphur Range 2%	100ml	B2336
501-968	Extreme Pressure Oil Sulphur Range 3.3% 33000ppmS	100ml	B2337
501-969	Extreme Pressure Oil Sulphur Range 4.19% 41900ppmS	100ml	B2338
502-023	Filling Funnel Borosilicate Glass	1	C4027
502-026	Residual Oil Standard Sulphur Range 1.5%	100ml	B2370
502-040	Smooth Wall Tin Capsules Round Base 18 x 6mm	100	D4007
502-040-100	Smooth Wall Tin Capsules Round Base 18 x 6mm	1000	D4015
502-049	Nitrogen Catalyst Pellets 502-049	50g	B1061
502-055	Orchard Leaves Standard 502-055	20g	B2141
502-062	Soil Standard (Sandy)	30g	B2180
502-071	High Sulphur Residual Oil Sulphur Range 30%	100ml	B2330
502-085	Zinc Sulphide Standard 32.90% S	50g	B2260
502-092	Ethylenediaminetetra-acetic Acid (EDTA) OAS	50g	B2115
502-092-250	Ethylenediaminetetra-acetic Acid (EDTA)	500g	B2144
502-167	Smooth Wall Tin Capsules Round Base 20 x 8mm	100	D4009
502-174	EMASorb A Granular 0.8 to 1.6mm 14 to 25 mesh	500g	B1162
502-174-HAZ	EMASorb A Granular 0.8 to 1.6mm 14 to 25 mesh	500g	B1162
502-176	EMASorb B Granular 1.6 to 3mm 7 to 14 mesh	500g	B1164
502-177	Silica (Quartz) Wool Very Fine	50g	B1102
502-181	Tungsten (VI) Oxide Granular	60g	B1217
502-186	Tin Foil Cones Standard Weight	100	D9001
502-186-100	Tin Foil Cones Standard Weight	1500	D9010
502-186-200	Tin Foil Cones Standard Weight	100	D9001
502-188	Aluminium Oxide Pellets	200g	B1163
502-189	Copper Wires Fine Wires Reduced 4 x 0.5mm	100g	B1015M
502-202	Coal Standard Sulphur Range 0.57%	50g	B2301
502-203	Stearic Acid OAS	5g	B2102
502-204	3,5-Dinitrobenzoic Acid OAS	5g	B2118
502-205	Caffeine OAS	5g	B2104
502-207	Cystine OAS	5g	B2105
502-209	Sulphamethazine OAS	5g	B2106
502-213	Snoop Leak Detection Fluid	236ml/8 fluid oz	E2039
502-258	Copper Turnings Fine Long Strands Reduced and Annealed	200g	B1107
502-272	Corn Gluten Organic Analytical Standard	30g	B2272
502-273	Alfalfa Organic Analytical Standard	30g	B2273
502-275	Rye Flour Organic Analytical Standard	30g	B2275
502-277	Barley Flour Organic Analytical Standard	30g	B2277
502-278	Rice Flour Organic Analytical Standard	30g	B2278
502-295	Copper Turnings Fine Long Strands Reduced and Annealed	200g	B1107
502-304	Copper Wires Fine Wires Reduced 4 x 0.5mm	100g	B1015M
502-304-500	Copper Wires Pound Pack Fine Wires Reduced 4 x 0.5mm	454g	B1083M
502-308	Medium Organic Content Soil Standard OAS	30g	B2178

## Cross references

### Macro CN/CHN/CNS/N-Protein analysis

Leco® part	Description	Pack	Cat. No.
502-309	Soil Standard (Peaty)	30g	B2176
502-310	Iron Wool Grade #2	450g	B1165
502-314	Silica (Quartz) Wool Very Fine	50g	B1102
502-321	Combustion Catalyst	250g	B1184
502-338	Cel Capsules Small	400	D9004
502-343	Ceramic Boat Liner Nickel 50 x 15 x 8mm	100	D5300
502-351	Halogen Scrubber 502-351	50g	B1269
502-359	Magnesium Oxide Beads 502-359	200g	B1190
502-382	Cel Capsules Medium 502-382	400	D9005
502-383	Coal CHNS Standard (S~0.25%) CRM	50g	B2320
502-384	Coal CHNS Standard (S~0.75%) CRM	50g	B2321
502-385	Coal CHNS Standard (S~2%) CRM	50g	B2322
502-387	Coal CHNS Standard (S~3%) CRM	50g	B2323
502-388	Coal CHNS Standard S=5.39 CRM	50g	B2324
502-397	Large Tin Foil Cones Standard Weight	100	D9002
502-397-400	Large Tin Foil Cones Standard Weight	400	D9003
502-433	Coal Standard Sulphur Range 0.35%	50g	B2300
502-434	Coal Standard Sulphur Range 0.7%	50g	B2302
502-435	Coal Standard Sulphur Range 1.09%	50g	B2304
502-436	Coal Standard Sulphur Range 1.48%	50g	B2305
502-437	Coal Standard Sulphur Range 3.03%	50g	B2308
502-438	Coal Standard Sulphur Range 5.13%	50g	B2311
502-642	Phenylalanine OAS	25g	B2148
502-654	25-(Bis(5-tert-butyl-2-benzo-oxazol-2-yl) thiophene (BBOT) OAS	25g	B2049
502-656	Copper Turnings Fine Long Strands Reduced and Annealed	200g	B1107
502-670	Coal Standard Sulphur Range 0.57%	50g	B2301
502-671	Coal Standard Sulphur Range 1.09%	50g	B2304
502-672	Coal Standard Sulphur Range 2.07%	50g	B2306
502-673	Coal Standard Sulphur Range 3.03%	50g	B2308
502-674	Coal Standard Sulphur Range 4.1%	50g	B2310
502-680	Coal CHNS Standard (S~0.25%) CRM	50g	B2320
502-681	Coal CHNS Standard (S~2%) CRM	50g	B2322
502-682	Coal CHNS Standard (S~2%) CRM	50g	B2322
502-683	Coal CHNS Standard (S~0.75%) CRM	50g	B2321
502-684	Coal CHNS Standard S=5.39 CRM	50g	B2324
502-812	Ethylenediaminetetra-acetic Acid (EDTA) OAS	50g	B2115
502-844	Copper Wires Fine Wires Reduced 4 x 0.5mm	100g	B1015M
503-032	Glass Scoop	1	C4060
528-203	Ceramic Boats Unglazed	100	C4036
528-203-250	Ceramic Boats Unglazed	250	C4137
529-026	Ceramic Crucibles	50	C4039
529-203	Ceramic Boats Unglazed	100	C4036
529-203	Ceramic Boats Unglazed	50	C4038
529-203-500	Ceramic Boats Unglazed	500	C4136
537-103	PolyFlow Tube 1/4 OD x 1/8 ID	1 ft	E2164
589-551	O Ring Sample Drop Block	1	E1112
601-132	Combustion U Tube CHN 800	1	C4330
601-387	Cooling Plate Stainless Steel	1	E2165
601-390	Furnace Filter Tube Borosilicate Glass	1	C4037
601-437	Catalyst Heater Tube Transparent Silica	1	C4023
601-442	O Ring Catalyst Heater Tube	1	E1101
601-483	Printer Paper American Letter 8.5 x 11	600 sheets	E2152
601-484	Printer Ribbon	1	E2153
601-504	O Ring Sample Drop Block	1	E1103
601-684	O Ring	1	E1344
601-691	Pinch Valve Tubing	1 ft	E2150
601-876	Pneumatic Cylinder 1 Stroke 3/8 Bore	1	E2183

The use of Leco® part numbers is intended for convenience only, and does not imply that the products are of Leco® origin. All Elemental Microanalysis products are guaranteed to be of high quality and are deemed to be suitable alternatives.

Macro CN/CHN/CNS/N-Protein analysis

Cross references

The use of Leco® part numbers is intended for convenience only, and does not imply that the products are of Leco® origin. All Elemental Microanalysis products are guaranteed to be of high quality and are deemed to be suitable alternatives.

Leco® part	Description	Pack	Cat. No.
601-883	Seal Piston FP228 328 428 528 CHN1000/CNS1000	1	E2238
601-936	Valve Block	1	E2196
601-937	Dosing Valve Stem Stainless Steel Without O Rings	1	E2166
601-939	O Ring	1	E1102
601-981	Cleaning Brush	1	E2154
602-605	Tube Fitting White Nylon 1/8 NPT to 3mm ID tube	1	E2181
602-672	Spring Dosing Valve Assembly	1	E2167
603-350	O-Ring Installation Tube	1	E2464
605-828	O Ring Combustion/Catalyst/Filter Tube	1	E1105
606-224	Thermocouple SC-432	1	E2205
606-286	Braided Cable (short strap)	1	E2772
606-308	Ceramic Stop	1	C4040
606-309	Outer Combustion Tube Ceramic	1	C4041
606-310	O Ring Outer Combustion Tube	1	E1120
606-312	O Ring Inner Combustion Tube	1	E1119
606-313	Inner Combustion Tube Ceramic	1	C4042
606-319	Braided Cable	1	E2736
606-320	Heating Element Clamp	1	E2204
606-327	Reagent Tube Borosilicate Glass	1	C4043
606-333	O Ring Combustion System	1	E1117
606-601	Heating Elements	4	E2206
608-339	Oxygen Lance CNS/CHN-1000	1	C4063
608-342	Inner Combustion Tube Silica CHN-1000	1	C4053
608-344	Outer Combustion Tube Ceramic CHN-1000	1	C4052
608-378	O Ring Inner Combustion Tube	1	E1119
608-379	Silica (Quartz) Wool Strips		B1192
608-505	Inner Combustion Tube Ceramic CNS1000	1	C4059
609-271	Radial shaft seal autoloader	1	E1134
611-431	O Ring Combustion System	1	E1118
611-476	O Ring Inner Combustion Tube	1	E1119
611-477	O Ring Outer Combustion Tube	1	E1120
612-340	O Ring	1	E1357
613-563	Braided Cable (short strap)	1	E2772
614-961	Porous Crucible	10	C4065
614-961-110	Porous Crucible	10	C4065
614-962	Oxygen Lance Short (lance length 4.75)	1	C4066
616-108	Combustion Tube FP-528	1	C4057
616-138	O-Ring Combustion Tube FP528/628	1	E1140
616-146	Oxygen Lance Long (Lance length 5.25")	1	C4051
616-147	Lance Assembly Complete	1	E2199
616-504	Particle Filter	1	E2369
616-632	Lance Tube Drilled	1	C4056
617-136	O Ring	1	E1345
617-441	Mesh screen filter	1	E2379
617-548	Reagent Tube	1	C4332
618-809	Filter tube	1	C4342
619-065	Combustion Tube Truspec/FP628	1	C4338
619-139	O Ring	1	E1358
619-154	Reduction Tube Truspec	1	C4339
619-192	O Ring	1	E1359
619-268	Tube TruSpec	1	C4341
619-425	Glass tube TruSpec	1	C4345
625-602-172	C-Flex Tubing Repl Kit	1	E2794
625-602-470	C-Flex Tubing Repl Kit	1	E2794
625-602-539	Reagent Tube Borosilicate Glass	1	C4043
633-101-460	Particle Filter	1	E2151

## Cross references











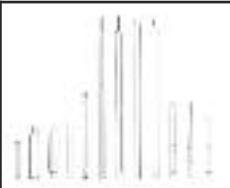



















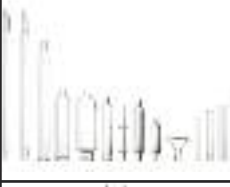

### Macro CN/CHN/CNS/N-Protein analysis

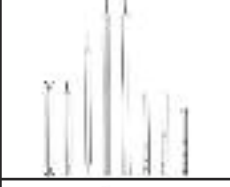
Leco® part	Description	Pack	Cat. No.
633-103-225	Reagent Tube	1	C4332
702-557	O ring	1	E1360
760-841	O Ring Combustion System	1	E1121
761-929	Crucible Tong	1	E2471
763-265	Glass Wool Borosilicate Fibres	227g	B1167
763-265	Glass Wool Rope Borosilicate Fibres	227g	B1267
763-379	O Ring Condensing Block	1	E1107
765-976	O Ring Filter Tube	1	E1133
767-757	Coal Standard Sulphur Range 2.07%	50g	B2306
767-758	Coal Standard Sulphur Range 2.63%	50g	B2307
767-759	Coke Standard Sulphur Range 1.21%	50g	B2316
768-980	Particle Filter	1	E2151
769-608	Halogen Trap Material	200g	B1526
769-610	F/Cl Trap Material	225g	B1527
770-764	Paper Roll SC32/132/232	1	E2244
770-778	Printer Ribbon CHN600/SC32/132/232/CR12	1	E2237
771-030	Bubble/Filter/Reagent Tube Borosilicate Glass	1	C4032
771-040	O Ring Sample Drop Block	1	E1114
771-407	O Ring	1	E1311
771-991	O Ring Precooler Assembly	1	E1122
772-269	O Ring Doser Valve Assembly	10	E1109
772-520	O Ring	1	E1110
772-738	O Ring Catalyst Heater Assembly	1	E1111
772-910	O Ring Sample Drop Block	1	E1100
772-992	Cooling Fan 80x80x38mm 115VAC	1	E2170
773-141	O Ring Reagent Tube	1	E1113
773-320	O Ring Reagent Tube	1	E1113
773-661	Tube Fitting Brass 10/32 to 1/16 ID tube	1	E2182
773-662	Polyu Tubing 1/8 OD x 1/16 ID	1ft	E2169
773-913	O Ring Sample Drop Block	1	E1114
774-425	O Ring	1	E1342
774-489	O Ring Combustion System	1	E1123
775-306	Secondary (screen) Filter	1	E2235
775-314	O Ring Combustion System	1	E1124
775-601	Reagent Tube Borosilicate Glass	1	C4004
775-880	Reagent/Filter Tube Borosilicate Glass	1	C4005
776-283	Oxygen Lance Transparent Silica	1	C4025
776-284	O Ring Combustion Tube	1	E1115
776-286	Combustion tube CHN 600	1	C4331
778-114	O Ring Catalyst Heater Tube	1	E1131
778-116	O Ring Ballast Tank	1	E1116
778-120	Neoprene Gasket Ballast Seal	1	E1125
780-831	O-Ring Lance Assembly FP528	2	E1139
780-899	Honeycomb Ceramic	1	C4058
780-911	Reduction Tube Transparent Silica	1	C4020
781-585	Thermocouple Type S	1	E2371
783-189	O-Ring	1	E1329
783-190	O-Ring	1	E1328
783-274	Oxygen Lance CHN1000	1	C4068
783-275	Lance Holder Block	1	E2197
783-276	Lance Holder Cover	1	E2198
783-278	Oxygen Lance CHN1000	1	C4068
783-608	Anhydrone Tube (Large)	1	C4336
783-897	O-Ring	1	E1328
UK-7753	Crucible Transparent Silica + pack of 50	1	C4046

The use of Leco® part numbers is intended for convenience only, and does not imply that the products are of Leco® origin. All Elemental Microanalysis products are guaranteed to be of high quality and are deemed to be suitable alternatives.

## Products from Elemental Microanalysis

Operating from Devon UK, our business holds three separate accreditations: ISO 9001 for our huge product range, supplying customers worldwide with high quality analytical consumables at value prices; ISO 17025 for our analytical services laboratory; and ISO 17034 for our new range of certified standards. Our qualified despatch and sales teams can organise safe, speedy and economical shipment of your orders worldwide by air, road or sea.

	SAMPLE ENCAPSULATION	GLASSWARE AND FURNACE TUBES	CHEMICAL REAGENTS	REFERENCE MATERIALS	OTHER PARTS AND CONSUMABLES
CHNOS (MICRO) ANALYSIS					
NITROGEN/PROTEIN DUMAS ANALYSIS					
INORGANIC ANALYSIS					
ORGANIC CARBON/SULPHUR ANALYSIS					
MACRO CHN CNS ANALYSIS					
EA-IRMS ANALYSIS					
TRACE NITROGEN, SULPHUR AND TOC ANALYSIS					

These pictures show only a small fraction of the thousands of products we have available for combustion elemental analysis.

For further information please request our catalogue for the application area you are interested in; we can also provide analyser specific consumables lists.

# Analysis Service



Over the past forty years our accumulated analytical expertise has been routinely applied to a diverse range of sample types and applications.

Typically we perform organic (C H N O S, TOC and nitrogen/protein), inorganic and stable isotope elemental determination. Our analysis systems are calibrated using NIST traceable reference standards.

- Results within 48 hours
- ISO 17025 UKAS accredited laboratory
- ISO 9001 & ISO 17034 accredited business

Whether you have a single sample or an on-going research program, we offer you commitment to precision and accuracy at an affordable price.



Serving elemental analysis customers for over 40 years



Elemental Microanalysis can supply product sheets tailored specifically to your analyser, product catalogues, and various other literature to help you find the products you need. This literature is available in printed or digital format – just tick the boxes, fill out your details and return the form to us or your local dealer. The latest editions of our Catalogues are also available to download from our website: [www.elementalmicroanalysis.com](http://www.elementalmicroanalysis.com)

Product sheets available, by analyser:

## Inorganic *(Please Tick)*

Bruker G4 Phoenix	
Bruker G4 Icarus CS	
Bruker G8 Galileo O, N, H	
Eltra CS2000	
Eltra CS800	
Eltra OH900	
Eltra ON900	
Horiba EMGA-620/621	
Horiba EMGA-800/900	
Horiba EMGA-821/921	
Horiba EMIA-320V2/920V2	
Horiba EMIA820V/320V/220V	
Leco 836/736 ONH/OH/NH/H	
Leco CS125/255	
Leco CS200/C200/S200/WC200	
Leco CS230	
Leco CS244/344/IR212/232	
Leco CS300	
Leco CS400/C400/S400	
Leco CS444/IR412/432	
Leco CS600	
Leco CS744/844	
Leco DH102/103/RH101	
Leco DH603	
Leco RH402	
Leco RH404	
Leco RO478	
Leco TC136/336/TN114/RO116	
Leco TC300/RO300/TN300	
Leco TC436/TN414/RO416	
Leco TC500/600	
Leco TCH600	
Leco WR112	

## Macro CHN/CNS *(Please Tick)*

Elementar rapid CS cube	
Elementar Vario Macro	
Elementar Vario Max CHN/CNS	
Elementar Vario Max Cube N/CN	
Elementar Vario Max N/CN	
Leco CHN1000/CNS1000	
Leco CHN2000	
Leco CHN600/800	
Leco CNS/NS/CN2000	
Leco Truspec CHN/CN	

## Micro/CHN(OS) *(Please Tick)*

Costech ECS4010	
Elementar CHN Rapid	
Elementar Pyro Cube	
Elementar Vario Micro Cube	
Elementar Vario EL	
Elementar Vario EL Cube	
Elementar Vario Isotope Cube	
Europa Roboprep/ANCA/Integra	
Eurovector EA3000	
Eurovector EA-3028HT	
Exeter CE240/440	
Hekatech HT-O	
Leco 900/932	
Leco Truspec Micro	
Perkin Elmer 2400	
Perkin Elmer 240ABC	
Picarro CM Model 02	
SerCon GSL/Integra	
Thermo EA1106CHNSO	
Thermo EA1108CHNSO	
Thermo EA1110CHNSO	
Thermo EA1112CHNSO/FLASH2000	
Thermo Flash 2000 IRMS	
Thermo Flash HT/HT Plus	
Thermo Flash Smart CHNOS	
Thermo NA1500NCS2	
Thermo TC/EA	
Thermo NA2500NCS	

## Organic Carbon/Sulphur *(Please Tick)*

Eltra CHS-580/CHS-580A	
Eltra CS-500	
Eltra Helios	
Leco SC632	
Leco SC832 series	
Leco TGA601/701	
Leco RC612	
Leco SC144	
Leco SC32/132/232/CR12	
Leco SC432/444/CR412	
Leco RC412	

## N/Protein *(Please Tick)*

Buchi DuMaster D-480	
CKIC TCN/CHN 2200	
Costech Turbo N	
Elementar Rapid N®	
Elementar Rapid N Cube®	
Elementar Rapid N exceed®	
Elementar Rapid MAX N exceed®	
Gerhardt Dumatherm®	
Leco FP2000	
Leco FP228	
Leco FP328	
Leco FP428	
Leco FP528	
Leco FP628	
Leco FP/CN928	
Leco TruMac	
Leco Truspec N	
Perkin Elmer 2410	
Thermo Flash 4000	
Thermo FlashSmart CHNOS/N-Protein	
Thermo NA1112Protein/FLASH2000	
Thermo NA2000/2100	
Velp NDA 701 Dumas Nitrogen Analyser	

## Trace *(Please Tick)*

Analytik Jena	
Antek 7000 from PAC	
Antek 9000 from PAC	
Antek MultiTek analyser from PAC	
Dohrmann DC	
Dohrmann DN	
Dohrmann MCTS	
Dohrmann DX	
Elementar LiquiTOC	
Elementar trace SN cube	
Elementar Vario TOC Cube	
Elementar Vario Trace S	
Metrohm 930 Combustion IC PP	
Shimadzu TOC	
TE Instruments	
Thermo Euroglas All Instruments	
TSHR Instruments	



Other literature available:

**Catalogues** *(Please Tick)*

Capsules	
Inorganic	
IRMS Supplement	
Laboratory Analysis Service	
Macro CHN/CNS	
Micro/CHN (OS)	
Nitrogen / Protein	
Organic Carbon / Sulphur	

**Reference materials/Standards for EA**

Pure chemical standards	
Natural materials	
Inorganic materials	
Isotope reference materials	

**Ion Chromatography** *(Please Tick)*

Dionex AS40/ADSV/ASAP/AS50/AS IC vials	
Metrohm Peak IC Autosampler IC vials	

*All trademarks acknowledged. Use of the OEM part number is for reference only and does not imply that the products are of OEM origin. All Elemental Products are guaranteed to be of high quality and suitable for use in the stated application.*

Can't find what you are looking for? Let us see if we can help: [info@microanalysis.co.uk](mailto:info@microanalysis.co.uk) or **+44 (0)183754446**

**What format would you like your literature in?**  
*(Please circle)*

**Print**

**Digital**

<b>Name</b>
<b>Organisation</b>
<b>Address</b>
<b>Tel</b>
<b>Email</b>

**Post, Fax or Email to:**  
**Elemental Microanalysis Ltd**  
**1 Hameldown Road**  
**Okehampton, Devon**  
**EX20 1UB UK**  
**F: +44 (0)1837 54544**  
**[info@microanalysis.co.uk](mailto:info@microanalysis.co.uk)**

**Or Your Local Dealer:**



[www.elementalmicroanalysis.com](http://www.elementalmicroanalysis.com)

Visit our website for up-to-date information, news, product releases and to subscribe to our mailing list.



Elemental Microanalysis Ltd.  
Hameldown Road  
Okehampton Business Park  
Okehampton  
Devon EX20 1UB  
United Kingdom  
**Tel: +44 (0)1837 54446**  
Fax: +44 (0)1837 54544  
Email: [info@microanalysis.co.uk](mailto:info@microanalysis.co.uk)

[www.elementalmicroanalysis.com](http://www.elementalmicroanalysis.com)

[www.elementallab.co.uk](http://www.elementallab.co.uk)



@ElementalLab



ElementalMicroanalysisCHNOS